

# bfm SEATING

## THE **2025** CATALOG



2025

design  
architecture  
hospitality  
dining

The  
AMERICAN  
CAFE & LOUNGE



**NP** New Product

**NC** New Color

**For Distributors Use Only**

place order | [orders@bfm1.com](mailto:orders@bfm1.com)

submit a claim | [returns@bfm1.com](mailto:returns@bfm1.com)

payment information | [AR@bfm1.com](mailto:AR@bfm1.com)

need a quote | [quotes@bfm1.com](mailto:quotes@bfm1.com)

need a freight quote | [freightquote@bfm1.com](mailto:freightquote@bfm1.com)



2080 Wheatsheaf Lane  
Philadelphia, PA 19124

T: 215-289-5411 F: 215-289-5420

[www.bfmseating.com](http://www.bfmseating.com)



# Table of Contents

## Outdoor Furniture

Alpha bases	33
Aruba lounge seating	38,39
Bali bases	30
Barneгат	15
Beachcomber tables	27
Belmar lounge seating	40,41,42
Boca bases	32
Captiva	8
Cancun booth	24
Cayman	36,37
Chesapeake	14
Daytona	10
Daytona table	11,27
Elite bases	33
Key West	9
Kingston	13
Largo	21
Longport 4-leg tables	22,28
Longport table tops	22,29
Maui	6
Margate bases	30
Marina	24
Monterey	23
Seaside	16
Seaside 4-leg tables	17,28
Seaside picnic table	18
Seaside table tops	17,29
Surf Inlay tables	19,28
Tahiti	7
Tribeca table tops	29,43

---

## Umbrellas

Aluminum market	52
Bolt-down	56
Cantilever	58
Crank lift fiberglass	48
Fiberglass market	46
G-series aluminum	54
G-series fiberglass	50
Umbrella bases	60-63
Umbrella base guide	125

---

## Industrial Seating

Barrick	67
Chester	66
Hamilton	71
Henry	74
Lima clear coat	75
Lincoln	63
Memphis	72
Nash	77
NV	70

---

## Steel Seating

Akrin	86
Bristol	89
Dale	81
Darby	83
Espy	82
Lima	79
Lima Silver Mist	80
Meghan	84

Polk .....	85
Trent .....	88
Troy .....	87

---

### Wood Seating

Aston .....	97
Berkeley .....	98
Columbia .....	95
Dover .....	94
Emma .....	91
Emma Cane Back .....	92
Giulia .....	95
Sofia .....	93
Stockton .....	99

---

### Indoor Tables & Bases

Alpha base .....	111
Atlas bases .....	106
Bolt-down bases .....	110
Cantilever & pin leg bases .....	110
Corner post legs .....	110
Elite bases .....	111
I-Beam bases .....	110
Jaxon bases .....	108
Midtown table tops .....	101
Niles bases .....	109
NV legs .....	110
Relic table tops .....	102
STB bases .....	109
Uptown bases .....	108,109
Urban bases .....	107
Wood veneer table tops .....	101

---

### Trash Receptacles

35 Gallon trash enclosures .....	112,113
----------------------------------	---------

---

### Server Stations

Single door server station .....	114,115
Double door server station .....	116,117

---

### Wireless Table Charging

Key, Battery, Charging Tray, Kits .....	104,105
---	---------

---

### Design

Quick Ship Vinyl .....	124
Grade 2 vinyl .....	125
Grade 3 vinyl .....	126,127
Grade 4 vinyl and fabric .....	128-133
Seat cushions .....	118-120
Steel seating wood seat options .....	124
Steel seating Relic seat options .....	124
Sunbrella® sofa cushion fabric .....	134,135
Sunbrella® patterns .....	136
Umbrella fabric .....	138

---

### Reference

Indoor Table Base Sizing Guide .....	140
Outdoor Table Base Sizing Guide .....	141
Terms & Conditions .....	142
Umbrella Base Guide .....	139

# Maui series



See page 120 for all cushion options.  
Cushions sold separately.

NP

## PRODUCT INFORMATION

PHVAC+finish	armchair dimensions   h32.25   w22   sh18   sd16   sw15.5
PHVSC+finish	side chair dimensions   h32.25   w17.5   sh18   sd16   sw15.5
PHVSB+finish	barstool dimensions   h40   w20   sh29.5   sd15.5   sw15.5
frame finish	WH ○ white   BL ● black
materials	aluminum   powder coat
feature	stackable (chairs only)

# Tahiti series



See page 120 for all cushion options.  
Cushions sold separately.

NP

## PRODUCT INFORMATION

PHXAC+finish	armchair dimensions   h31   w22   sh17.75   sd17.5   sw15.5
PHXSC+finish	side chair dimensions   h30.25   w18   sh17.75   sd17   sw15.5
PHXSB+finish	barstool dimensions   h40.75   w18   sh30   sd16   sw15.5
weave colors	GR ● medium gray   BL ● black
frame finish	WH ○ white   BL ● black
materials	aluminum   powder coat   Phifertex®   rope
feature	stackable

# Captiva series



## PRODUCT INFORMATION

PH401C armchair dimensions | h30.5 | w16.75 | sh17 | sd15.5 | sw16.75

PH402C side chair dimensions | h30.5 | w16.75 | sh17 | sd15.5 | sw16.75

PH402B barstool dimensions | h39.75 | w18.5 | sh29.25 | sd14.5 | sw15

weave colors GR ● seaside gray | SB ● sahara brown

frame finish WH ● white | BL ● black

materials synthetic rope | aluminum | powder coat

feature stackable (chairs only)



# Key West series



See page 118 for all cushion options.  
Cushions sold separately.

## PRODUCT INFORMATION

PHKWAC+finish	armchair dimensions   h31   w21.25   sh17.75   sd16.5
PHKWSC+finish	side chair dimensions   h31.25   w19.5   sh17.5   sd16.5
PHKWBS+finish	barstool dimensions   h39.75   w20.5   sh29.25   sd15.25
frame finish	WH ○ white   SG ● soft gray   BL ● black   BY ● berry
materials	aluminum   powder coat
feature	stackable

# Daytona series



## PRODUCT INFORMATION

SU2811CSG	armchair dimensions   h33   w21.5   sh18   sd16   sw16   armht25.5
SU2810CSG	side chair dimensions   h33   w17.75   sh18   sd16   sw16
SU2810BSG	barstool dimensions   h42   w18.5   sh30   sd14.25   sw16
frame finish	SG ● soft gray   BL ● black
materials	e-coated steel   powder coated
feature	stackable

# Daytona tables



## PRODUCT INFORMATION

SUD+size+U	table dimensions   24 x 32   32 x 32   32 x 48   36 x 36 dining height
SUD3232UT	table dimensions   32 x 32 bar height
frame finish	SG ● soft gray   BL ● black
materials	e-coated steel   powder coated
feature	ADA compliant sizes available   umbrella holes   weighted umbrella base required sold separately, see page 60



# Kingston series



## PRODUCT INFORMATION

SU1601CBL armchair dimensions | h32.25 | w21.25 | sh17.5 | sd14.5 | sw17.5 | armht25.75

SU1600CBL side chair dimensions | h32.25 | w20.25 | sh17.5 | sd14.5 | sw17.75

SU1600BBL barstool dimensions | h39.75 | w19 | sh29.75 | sd13.5 | sw15.5

frame finish BL ● black

materials e-coated steel | powder coated | steel micro mesh

feature stackable

# Chesapeake series



## PRODUCT INFORMATION

SU1301CBL armchair dimensions | h34 | w21 | sh17.5 | sd17.5 | sw17 | armht25.5

SU1300CBL side chair dimensions | h34 | w17.75 | sh17.5 | sd17.5 | sw17

SU1300BBL barstool dimensions | h43.5 | w17.25 | sh30 | sd15.5 | sw16

frame finish BL ● black

materials e-coated steel | powder coated | steel micro mesh

features stackable

# Barnegat tables

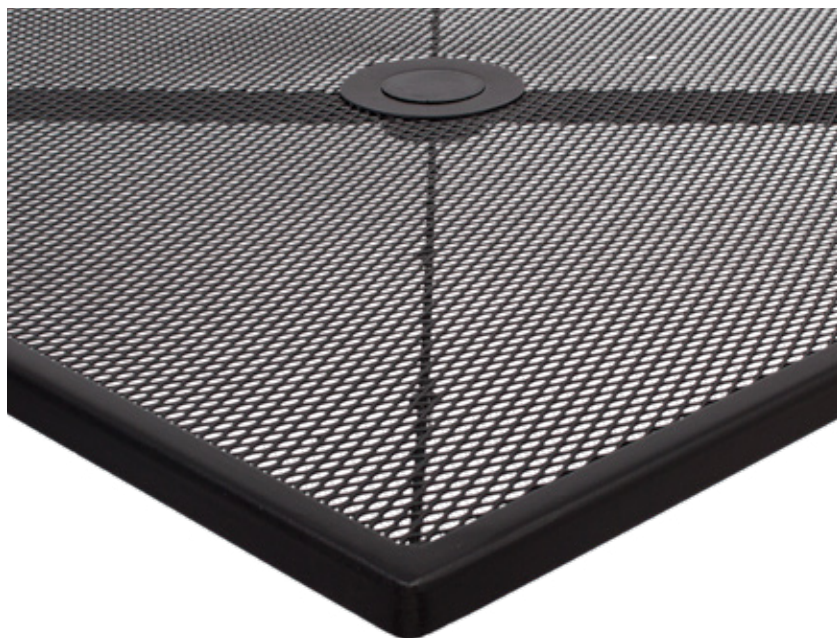

## PRODUCT INFORMATION

SU+size+BL-D table dimensions | 24 x 32 | 30 x 30 | 36 x 36 | 24R | 30R | 36R | 42R | dining height

SU+size+BL-T table dimensions | 24 x 32 | 30 x 30 | 36 x 36 | 24R | 30R | 36R | 42R | bar height

frame finish BL ● black

materials e-coated steel | powder coated | steel micro mesh

feature umbrella compatible (weighted umbrella base required, sold separately, see pg. 60 no umbrella hole 24R)

# Seaside series



## PRODUCT INFORMATION

PH201CGRTK+finish	armchair dimensions   h33   w22   sh17.5   sd17.5   sw19.5   armht24
PH202CGRTK+ finish	side chair dimensions   h33   w19   sh17.5   sd17.5   sw16
PH201BGRTK+finish	arm barstool dimensions   h45   w22   sh29.5   sd17.5   sw19.5   armht36
PH202BGRTK+finish	side barstool dimensions   h45   w18.75   sh29.5   sd17.5   sw15.5
frame finish	SG ● soft gray   BL ● black
materials	aluminum   powder coat   gray synthetic teak
feature	armchair and side chair stackable



# Seaside tables



## PRODUCT INFORMATION

PH+size+GR+finish	table top dimensions   24 x 30   30 x 30   34 x 34   30 x 51
base options	alpha   bali   margate
PH4L+size+GR+finish	4-leg table dimensions   31 x 31   35 x 35   31 x 48   35 x 72   dining height
PH4L+size+GR+finish+T	4-leg table dimensions   31 x 48   35 x 72   bar height
frame finish	SG ● soft gray   BL ● black
materials	aluminum   powder coat   gray synthetic teak
features	ADA compliant sizes available   umbrella hole not available on 24 x 30 tops or 4-leg bar height tables   margate base supports umbrella   weighted umbrella base required 4-leg and 30 x 51 tables, see page 60

Attention: refracting sunlight from stemware or a concentrated heat source may cause damage to synthetic surface, voiding warranty"

# Seaside series

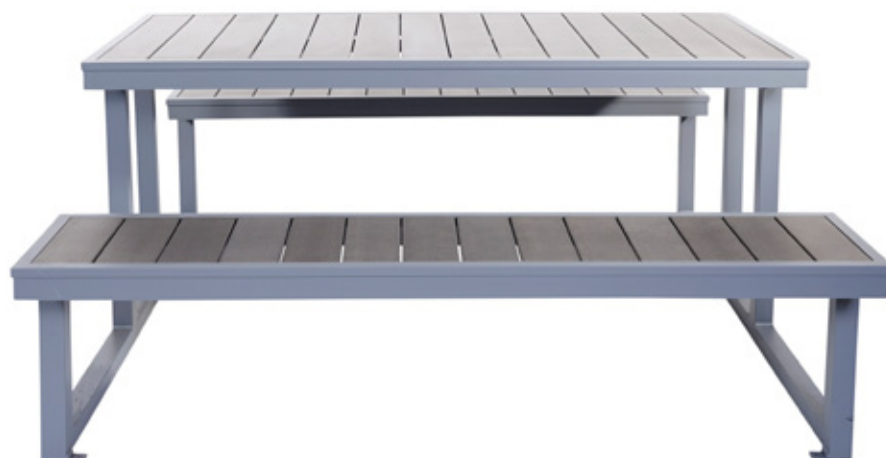

## PRODUCT INFORMATION

PH5927GR	dimensions   top 27.5 d x 59 w x 29.5 h   seat 12.5 d x 59 w x 18 h   overall 60.25 d
PH7227GR	dimensions   top 27.5 d x 72 w x 29.5 h   seat 12.5 d x 72 w x 18 h   overall 60.25 d
frame finish	SG ● soft gray   BL ● black
materials	aluminum   powder coat   gray synthetic teak
features	umbrella hole optional   weighted umbrella base required, sold separately, see page 60

Attention: refracting sunlight from stemware or a concentrated heat source may cause damage to synthetic surface, voiding warranty"

# Surf Inlay series



## PRODUCT INFORMATION

PH4L+ size + finish	4-leg table dimensions   32x32   36x36   32x48   36x72   dining height
PH4L+ size + finish + T	4-leg table dimensions   32x48   36x72   bar height
inlay	CR ● carrara   ● PR pietro
frame finish	WH ● white   SG ● soft gray   BL ● black
materials	aluminum   powder coat   compact laminate
features	umbrella hole optional   weighted umbrella base required, sold separately, see page 60 ADA compliant sizes available   umbrella hole not available on bar height tables



# Largo series



## PRODUCT INFORMATION

PH101CTK+finish	armchair dimensions   h33   w22   sh17.25   sd18   sw19   armht24
PH102CTK+finish	side chair dimensions   h33   w18.5   sh17.5   sd17   sw16.5
PH101BTK+finish	arm barstool dimensions   h45.75   w22   sh29.25   sd18   sw19   armht36
PH102BTK+finish	side barstool dimensions   h45.5   w18.5   sh29.75   sd17.5   sw16.5
frame finish	BL ● black   SV ● silver
materials	aluminum powder coat   synthetic teak
feature	armchair and side chair stackable

# Longport tables



## PRODUCT INFORMATION

PH+size+TK+finish	table top dimensions   24 x 24   24 x 30   32 x 32   35 x 35   32 x 48   24R   32R   34R
base options	alpha   bali   margate
PH4L+size+TK+finish	4-leg table dimensions   32 x 32   35 x 35   32 x 48   35 x 71   dining height
PH4L+size+TK+finish+T	4-leg table dimensions   32 x 48   35 x 71   bar height
frame finish	BL ● black   SV ● silver
materials	aluminum powder coat   synthetic teak table top
features	ADA compliant sizes available   umbrella hole not available on 24x24, 24x30 tops or 4-leg bar height tables   margate base supports umbrella   weighted umbrella base required 4-leg and 32x48 tables, see page 60

Attention: refracting sunlight from stemware or a concentrated heat source may cause damage to synthetic surface, voiding warranty.

# Monterey series



## PRODUCT INFORMATION

PH501CJV armchair dimensions | h34.5 | w21.75 | sh18 | sd17 | sw 18 | armht24

PH500CJV side chair dimensions | h34 | w19 | sh18 | sd17 | sw 16

PH500BJV barstool dimensions | h42.25 | w18.75 | sh29.75 | sd16 | sw 18.5

wicker color JV ● java

materials aluminum | outdoor synthetic weave

features stackable side and armchair | aluminum leg endcaps

# Cancun booth



See page 120 for all cushion options.  
Cushions sold separately.

## Marina series



### PRODUCT INFORMATION

PH7100JV	Cancun booth bench dimensions   h37.5   w48   sh17.5   sd18
wicker color	JV ● java
materials	aluminum frame   powder coat   outdoor synthetic weave
features	2" cushion available   aluminum foot caps
PH11CBBBL	Marina armchair dimensions   h30   w21   sh17.75   sd18   sw19.5   armht27
PH10BBBBL	Marina backless barstool dimensions   h30.75   w17.25   sd13.25   sw13.25
frame finish	black powder coat   brown/black weave & binding
materials	aluminum frame   powder coat   outdoor synthetic weave   2" cushion available, sold separately
feature	armchair stackable





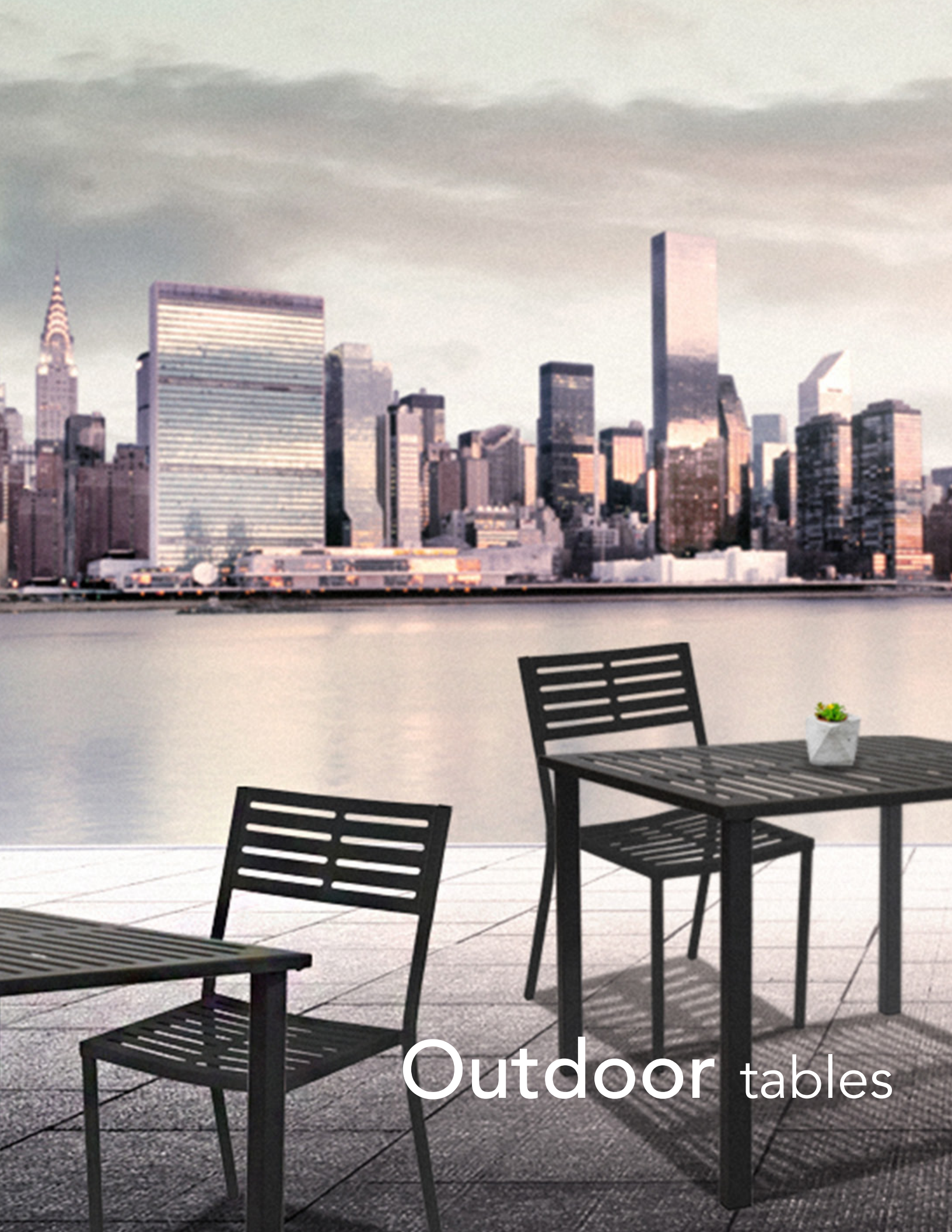

Outdoor tables

## Daytona tables



SUD2432U | 4-leg dining height table | 24 x 32

SUD3232U | 4-leg dining height table | 32 x 32

SUD3248U | 4-leg dining height table | 32 x 48

SUD3636U | 4-leg dining height table | 36 x 36

SUD3232UT | 4-leg bar height table | 32 x 32

finish | SG ● soft gray | BL ● black

materials | aluminum | powder coat

feature | corner leg design | umbrella capability | weighted umbrella base required, sold separately, see page 60  
ADA compliant sizes available

## Beachcomber tables



PHB2432 | dining height table | 24 x 32

PHB3232 | dining height table | 32 x 32

PHB3248 | dining height table | 32 x 48

PHB3636 | dining height table | 36 x 36

PHB2432T | bar height table | 24 x 32

PHB3232T | bar height table | 32 x 32

PHB3636T | bar height table | 36 x 36

PHB3048T | bar height table | 30 x 48

finish | WH ○ white | BL ● black | BY ● berry

materials | powder coated aluminum

base option | margate or bali | margate supports umbrella

30x48 tables require weighted umbrella base, sold separately  
see page 60



## Surf Inlay tables



NC

- PH4L3232TK | 4-leg bolt-down table | 32 x 32
- PH4L3248TK | 4-leg bolt-down table | 32 x 48 (ADA compliant)
- PH4L36365TK | 4-leg bolt-down table | 36 x 36
- PH4L3672TK | 4-leg bolt-down table | 36 x 72 (ADA compliant)
- PH4L3248TKT | 4-leg bolt-down table bar height | 32 x 48
- PH4L3671TKT | 4-leg bolt-down table bar height | 36 x 71
- inlay | CR  carrara |  PR pietro
- frame finish | WH  white | SG  soft gray | BL  black
- materials | aluminum | powder coat | compact laminate

umbrella hole optional | weighted umbrella base required, sold separately, see page 60 | ADA compliant sizes available  
 umbrella hole not available on bar height tables | bolt-down feature

## Seaside tables



- PH4L3131GR | 4-leg bolt-down table | 31 x 31
- PH4L3148GR | 4-leg bolt-down table | 31 x 48 (ADA compliant)
- PH4L3535GR | 4-leg bolt-down table | 35 x 35
- PH4L3572GR | 4-leg bolt-down table | 35 x 72 (ADA compliant)
- PH4L3148GRT | 4-leg bar height bolt-down table | 31 x 48
- PH4L3572GRT | 4-leg bar height bolt-down table | 35 x 72
- finish | synthetic teak | frame options BL  black | SG  soft gray
- materials | synthetic wood | aluminum | powder coat
- feature | corner leg design | umbrella hole optional (dining height only) | weighted umbrella base required, sold separately, see page 60 | ADA compliant sizes available  
 bolt-down feature

## Longport tables



- PH4L3232TK | 4-leg bolt-down table | 32 x 32
- PH4L3248TK | 4-leg bolt-down table | 32 x 48 (ADA compliant)
- PH4L3535TK | 4-leg bolt-down table | 35 x 35
- PH4L3571TK | 4-leg bolt-down table | 35 x 71 (ADA compliant)
- PH4L3248TKT | 4-leg bolt-down table bar height | 32 x 48
- PH4L3571TKT | 4-leg bolt-down table bar height | 35 x 71
- finish | synthetic teak | frame options BL  black | SV  silver
- materials | synthetic wood | aluminum | powder coat
- feature | corner leg design | umbrella hole optional (dining height only) | weighted umbrella base required, sold separately, see page 60 | ADA compliant sizes available  
 bolt-down feature

## Seaside table tops



PH2430GRTK | 24 x 30

PH3030GRTK | 30 x 30

PH3434GRTK | 34 x 34

PH3051GRTK | 30 x 51

finish | SG ● soft gray edge | ● BL black edge

materials | gray synthetic teak | aluminum sub-frame  
powder coat

base option | margate or bali or alpha | margate supports  
umbrella | 30 x 51 requires weighted umbrella  
base, sold separately, see page 60

feature | umbrella hole upon request (margate only)

## Longport table tops



PH2424TK | 24 x 24

PH3248TK | 32 x 48

PH2432TK | 24 x 32

PH24RTK | 24R

PH3232TK | 32 x 32

PH32RTK | 32R

PH3636TK | 35 x 35

PH36RTK | 34R

finish | SV ● silver edge | BL ● black edge

materials | synthetic teak | aluminum sub-frame | powder coat

base option | margate or bali or alpha | margate supports um-  
brella | 32x48 requires a weighted umbrella base,  
sold separately, see page 60

feature | umbrella hole upon request (margate only) except 24x24 & 24R

Attention: refracting sunlight from stemware or a concentrated heat source may cause damage to synthetic surface, voiding warranty.

## Tribeca table tops

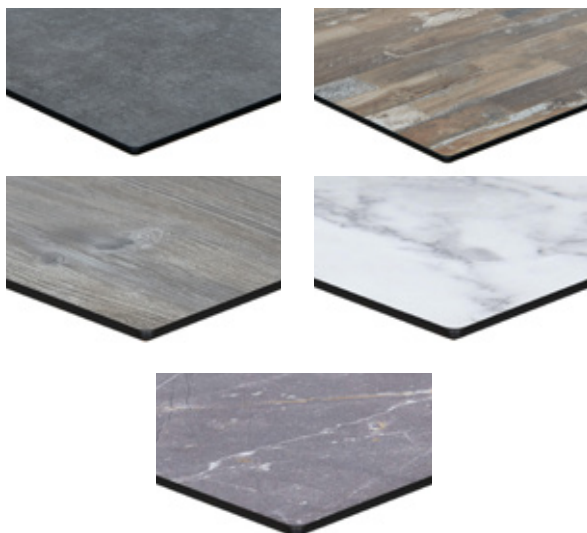

TRN2432+finish | 24 x 32

TRN32R+finish | 32R

TRN3232+finish | 32 x 32

TRN36R+finish | 36R

TRN3248+finish | 32 x 48

TRN48R+finish | 48R

TRN3636+finish | 36 x 36

finish | FS ● frosted slate | DW ● driftwood

CR ● carrara | PR ● pietro | PP ● planked pine

materials | compact laminate

feature | umbrella hole optional (margate bases only)  
32x48 requires a weighted umbrella base, sold separately, see page 60

# Outdoor bases



## Margate

PHBT+size+SQ | square dining height

PHBT+size+SQT | square bar height

base dimension | 16 x 16 | 18 x 18 | 20 x 20  
24 x 24

finish | BL ● black | SV ● silver  
Additional 18sq & 20sq base finishes  
WH ○ white | BY ● berry

materials | powder coated | zinc plated cast iron  
stainless steel column

features | center post base with umbrella  
capabilities, pinch nut



## Margate

PHTB+size+R | round dining height

PHTB+size+RT | round bar height

base dimension | 16 | 18 | 20 | 24

finish | BL ● black | SV ● silver

materials | powder coated | zinc plated cast  
iron, stainless steel column

features | center post base with umbrella  
capabilities, pinch nut



## Bali

PHTB2626 | cross base dining height

PHTB2626T | cross base bar height

base dimension | 26 x 26

finish | BL ● black | SV ● silver  
WH ○ white | BY ● berry

materials | powder coated cast  
aluminum

feature | additional cast weight



## Bali end

PHTB0022 | dining height (sold as pair)

PHTB0022T | bar height (sold as pair)

base dimension | 22 x 3.25

finish | BL ● black | SV ● silver  
WH ○ white | BY ● berry

materials | powder coated | weighted cast  
aluminum

feature | compatible with Margate series



## Bali folding

PHTB2626F | folding dining height

base dimension | 26 x 26

finish | BL ● black | SV ● silver

materials | powder coated, weighted  
cast aluminum

feature | folding

capabilities | safely holds up to 32" top



# Outdoor bases



## Boca

PHTB501 | 4-leg dining height

base spread | 24"

finish | BL ● black

materials | powder coated cast aluminum



## Boca bar height

PHTB503 | 4-leg bar height

base spread | 24"

finish | BL ● black

materials | powder coated cast aluminum



## Boca umbrella

PHTB502 | umbrella base standard height

base spread | 33"

finish | BL ● black

materials | powder coated cast aluminum

feature | umbrella compatible  
(weighted umbrella base required, sold separately, see page 60)



## Boca trestle

PHTB504 | trestle base standard height

base spread | 24" x 36.5"

supports | 32 x 48

finish | BL ● black

materials | powder coated cast aluminum



# Outdoor bases



## Elite square

PHTB+size+SQSS | dining height

PHTB+size+SQSST | bar height

base dimension | 18 x 18 | 24 x 24

materials | 304 brushed stainless steel



## Elite round

PHTB+size+RSS | dining height

PHTB+size+RSST | bar height

base dimension | 18 | 24

materials | 304 brushed stainless steel



## Elite end

PHTB0024SS | dining height (sold as pair)

PHTB0024SST | end bases bar height (sold as pair)

base dimension | 4 x 24

materials | 304 brushed stainless steel

feature | ADA capabilities



## Elite double column

PHTB1630SS | dining height

PHTB1630SST | bar height

base dimension | 16 x 30

materials | 304 brushed stainless steel



## Alpha

PHTB-BDSS | bolt-down base dining height

PHTB-BDSST | bolt-down base bar height

base dimension | 8

finish | SS ● stainless steel

materials | 304 brushed stainless steel powder coated

capabilities | bolt down



## Alpha

PHTB-BD

PHTB-BDT | bolt-down base bar height

base dimension | 8

finish | BL ● black | SV ● silver

materials | 304 stainless steel

capabilities | bolt down



Modular seating



# Cayman Series



PHP + cushion color + frame finish | sofa

dimensions | h27.5 | w87.75 | d31

frame finish | WH ○ white | BL ● black

rope colors | BL ● black | GR ● medium gray

materials | aluminum | polyester rope

features | sold separately | Sunbrella® outdoor upholstery fabrics  
(cushions only) upholstery found on pages 134–136



PHPA + cushion color + frame finish | armchair

dimensions | h27.50 | w31.5 | d31.5

frame finish | WH ○ white | BL ● black

rope colors | BL ● black | GR ● medium gray

materials | aluminum | polyester rope

features | sold separately | Sunbrella® outdoor upholstery fabrics  
(cushions only) upholstery found on pages 134–136

NP



PHPM + cushion color + frame finish | middle

dimensions | h27.5 | w25.75 | d31

frame finish | WH ○ white | BL ● black

rope colors | BL ● black | GR ● medium gray

materials | aluminum | polyester rope

features | sold separately | Sunbrella® outdoor upholstery fabrics  
(cushions only) upholstery found on pages 134–136



PHPC + cushion color + frame finish | corner

dimensions | h27.5 | w31 | d31

frame finish | WH ○ white | BL ● black

rope colors | BL ● black | GR ● medium gray

materials | aluminum | polyester rope

features | sold separately | Sunbrella® outdoor upholstery fabrics  
(cushions only) upholstery found on pages 134–136

NP

# Aruba series



PH5101JV-L/R | left or right arm sofa

dimensions | h26 | w29 | d29

finish | java

materials | aluminum | synthetic wicker

features | 4" seat cushion with wedge design back | cushion D-hooks | sectional connection hooks | L sectional capability

cushion | sold separately | 73 colors available  
upholstery found on pages 134–136



PH5101JV-MW | large middle sofa

dimensions | h26 | w25.25 | d29

finish | java

materials | aluminum | synthetic wicker

features | 4" seat cushion with wedge design back | cushion D-hooks | sectional connection hooks | L sectional capability

cushion | sold separately | 73 colors available  
upholstery found on pages 134–136



PH5101JV-C | corner sofa

dimensions | h26 | w29 | d29

finish | java

materials | aluminum | synthetic wicker

features | 4" seat cushion with wedge design back | cushion D-hooks | sectional connection hooks | L sectional capability

cushion | sold separately | 73 colors available  
upholstery found on pages 134–136



PH5102JV | armchair

dimensions | h26 | w29 | d29

finish | java

materials | aluminum | synthetic wicker

features | 4" seat cushion with wedge design back | cushion D-hooks

cushion | sold separately | 73 colors available  
upholstery found on pages 134–136



PH5106JV | ottoman

dimensions | h14 | w25 | d25

finish | java

materials | aluminum | synthetic wicker

features | 4" seat cushion

cushion | sold separately | 73 colors available  
upholstery found on pages 134–136

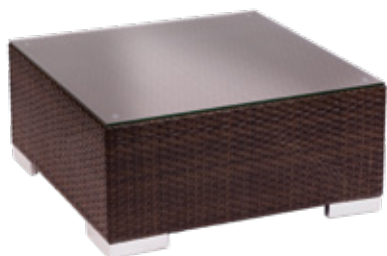

PH5104JV | coffee table

dimensions | h14 | w30 | d30

finish | java

materials | aluminum | synthetic wicker

feature | tempered glass sold separately

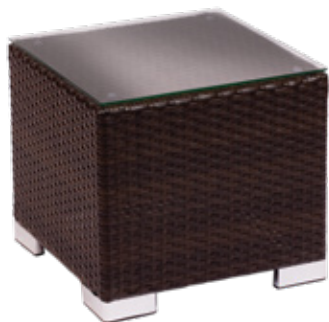

PH5105JV | end table

dimensions | h16 | w18 | d18

java

materials | aluminum, synthetic wicker

feature | tempered glass sold separately

# Belmar series



PH6101-L | left arm facing sectional

dimensions | h25.75 | w28.25 | d28.25

finish | SG ● soft gray | BL ● black

materials | aluminum powder coat

features | 6" seat cushion with wedge design back | cushion D-hooks | sectional connection hooks | L sectional capability

cushion | sold separately | 73 colors available  
upholstery found on pages 134–136



PH6101-R | right arm facing sectional

dimensions | h25.75 | w28.25 | d28.25

finish | SG ● soft gray | BL ● black

materials | aluminum powder coat

features | 6" seat cushion with wedge design back | cushion D-hooks | sectional connection hooks | L sectional capability

cushion | sold separately | 73 colors available  
upholstery found on pages 134–136





PH6101-M | armless middle sofa

dimensions | h25.75 | w25.5 | d28.25

finish | SG ● soft gray | BL ● black

materials | aluminum powder coat

features | 6" seat cushion with wedge design back | cushion D-hooks | sectional connection hooks | L sectional capability

cushion | sold separately | 73 colors available  
upholstery found on pages 134–136



PH6102 | armchair

dimensions | h25.75 | w28.25 | d28.25

finish | SG ● soft gray | BL ● black

materials | aluminum powder coat

features | 6" seat cushion with wedge design back | cushion D-hooks

cushion | sold separately | 73 colors available  
upholstery found on pages 134–136



PH6106 | ottoman

dimensions | h12 | w27.5 | d25.5

finish | SG ● soft gray | BL ● black

materials | aluminum powder coat

features | 6" seat cushion

cushion | sold separately | 73 colors available  
upholstery found on pages 134–136

# Belmar series



PH6104 | coffee table  
dimensions | h16 | w47 | d23.5  
finish | SG ● soft gray | BL ● black  
materials | aluminum powder coat  
feature | large 2" legs with slat design surface



PH6105 | end table  
dimensions | h16 | w21.5 | d21.5  
finish | SG ● soft gray | BL ● black  
materials | aluminum powder coat  
feature | large 2" legs with slat design surface

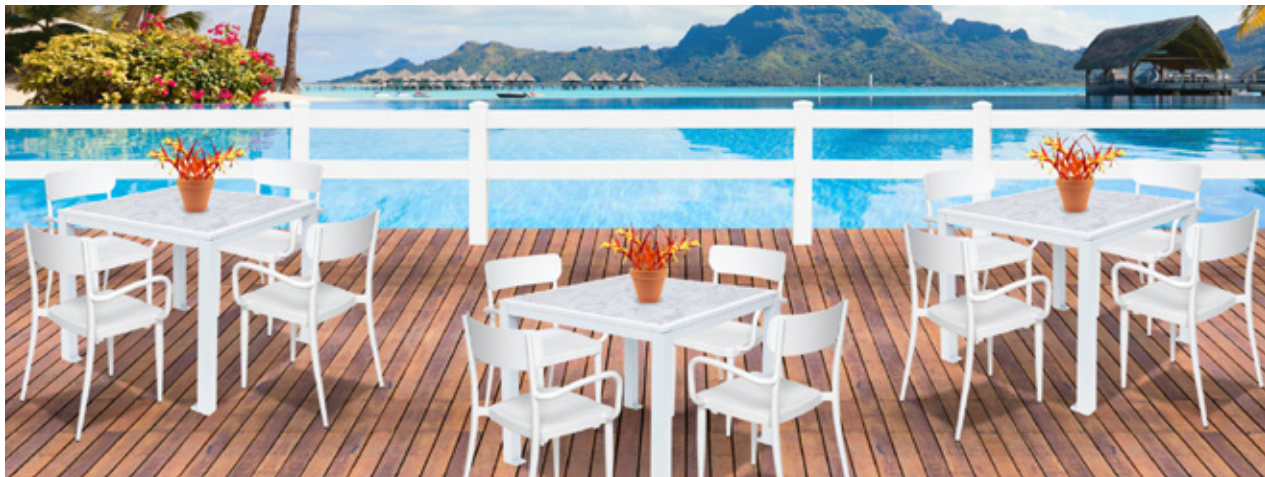

# Inlay series



NC

## SURF INLAY

PH4L + size + table color + frame finish | dining table

dimensions | 36x36 | 32x48 | 32x48 bar height  
36x72 | 36x72 bar height

finish | WH ○ white | SG ● soft gray | BL ● black

table top | CR ● carrara | ● PR pietro

materials | aluminum powder coat | compact laminate

umbrella hole optional | weighted umbrella base required, sold separately, see page 60 | ADA compliant sizes available  
umbrella hole not available on bar height tables



NC

## BELMAR INLAY

PH6104 + inlay color + finish color | coffee table

dimensions | h16 | w47 | d23.5

finish | WH ○ white | SG ● soft gray | BL ● black

inlay | CR ● carrara | ● PR pietro

materials | aluminum powder coat | compact laminate

feature | large 2" legs



## BELMAR INLAY

PH6105 + inlay color + finish color | end table

dimensions | h16 | w21.5 | d21.5

finish | WH ○ white | SG ● soft gray | BL ● black

inlay | CR ● carrara | ● PR pietro

materials | aluminum powder coat | compact laminate

feature | large 2" legs



Umbrellas



# Fiberglass Market umbrellas



PULLEY LIFT

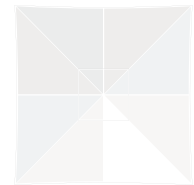
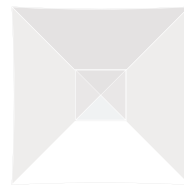
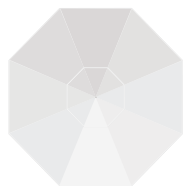

## AVAILABLE FRAME SIZES

U7.5F: 7.5' OCTAGON	U9F: 9' OCTAGON	U11F: 11' OCTAGON	U6.5F: 6.5' SQUARE	U7.5SQF: 7.5' SQUARE
A: height: 94"	A: height: 97"	A: height: 107"	A: height: 97"	A: height: 107"
B: clearance: 76"	B: clearance: 77"	B: clearance: 82"	B: clearance: 77"	B: clearance: 82"
C: upper pole 66"	C: upper pole 69"	C: upper pole 77"	C: upper pole 69"	C: upper pole 77"
D: lower pole: 37"	D: lower pole: 37"	D: lower pole: 37"	D: lower pole: 37"	D: lower pole: 37"
mast diameter: 1.5"	mast diameter: 1.5"	mast diameter: 1.5"	mast diameter: 1.5"	mast diameter: 1.5"
weight: 16 lbs.	weight: 20 lbs.	weight: 22 lbs.	weight: 15 lbs.	weight: 18 lbs.
frame finish SV  silver   SM  silver mist   WG  wood grain   BL  black   BZ  bronze   WH  white   HW  Heather Willow   CB  Carbon				
fabric color options on page 138				



COMMERCIAL PULLEY SYSTEM



HIGH IMPACT POLYMER JOINTS AND  
.5" FIBERGLASS RIBS



1.5" DIAMETER CENTER POLE

HIGH IMPACT TPU COPOLYMER FINIALS



Standard: CLASSIC BALL FINIAL  
Finial will match selected frame finish



Optional: VERTEX FINIAL  
Finial will match selected frame finish

FINISHES AVAILABLE

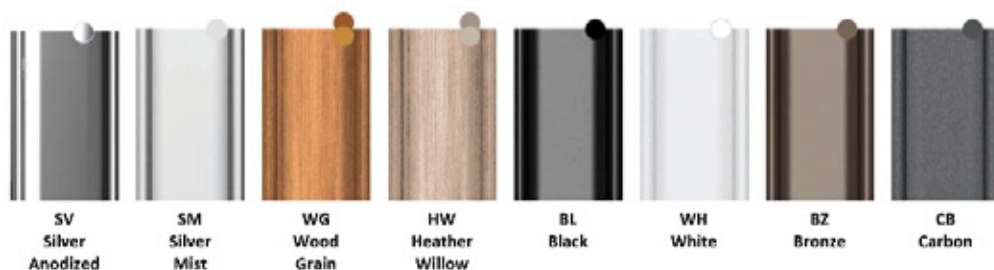

FEATURES

- Smooth and effortless pulley system.
- 1/2" fiberglass ribs and struts for maximum strength and flexibility.
- 1.5" diameter center pole with a 1/8" aluminum wall thickness provides incredible strength and durability.
- Stainless steel grommets attach the canopy securely to the frame.
- Modular design.
- Stainless steel hardware throughout.

BASE OPTIONS

- UB100RSM aluminum shell (page 60) | UB70RD resin coated concrete (page 60) | UB50RD resin coated concrete (page 60)
- UB75SQ steel plate (page 60) | UBBD camlock (page 63) | UBG24RSM galvanized steel (page 61) | UBG30RSM galvanized steel (page 61)

# Crank Lift Fiberglass umbrellas



COMMERCIAL CRANK LIFT - NO TILT

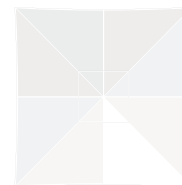
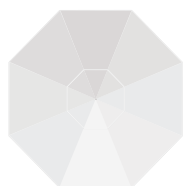

## AVAILABLE FRAME SIZES

U7.FC: 7.5' OCTAGON      U9FC: 9' OCTAGON      U11FC: 11' OCTAGON      U6.5FC: 6.5' SQUARE      U7.5SQFC: 7.5' SQUARE

A: height: 98"

A: height: 107"

A: height: 108"

A: height: 107"

A: height: 108"

B: clearance: 72"

B: clearance: 79"

B: clearance: 87"

B: clearance: 79"

B: clearance: 87"

C: upper pole 66"

C: upper pole 69"

C: upper pole 77"

C: upper pole 69"

C: upper pole 77"

D: lower pole: 37"

D: lower pole: 37"

D: lower pole: 37"

D: lower pole: 37"

D: lower pole: 37"

mast diameter: 1.5"

mast diameter: 1.5"

mast diameter: 1.5"

mast diameter: 1.5"

mast diameter: 1.5"

weight: 17 lbs.

weight: 22 lbs.

weight: 24 lbs.

weight: 18 lbs.

weight: 21 lbs.

frame finish SV silver | SM silver mist | WG wood grain | BL black | BZ bronze | WH white | HW Heather Willow | CB Carbon

fabric color options on page 138





COMMERCIAL CRANK SYSTEM



HIGH IMPACT POLYMER JOINTS AND .5" FIBERGLASS RIBS

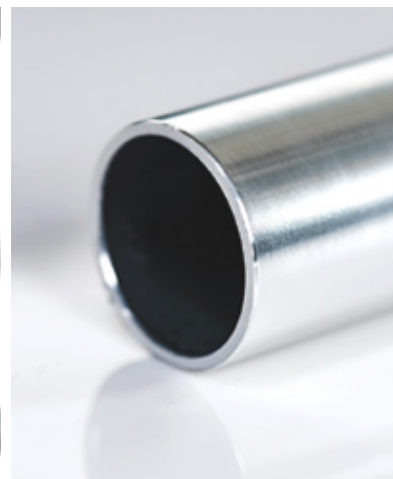

1.5" DIAMETER CENTER POLE

HIGH IMPACT TPU COPOLYMER FINIALS



Standard: CLASSIC BALL FINIAL  
Finial will match selected frame finish.



Optional: VERTEX FINIAL  
Finial will match selected frame finish.

FINISHES AVAILABLE

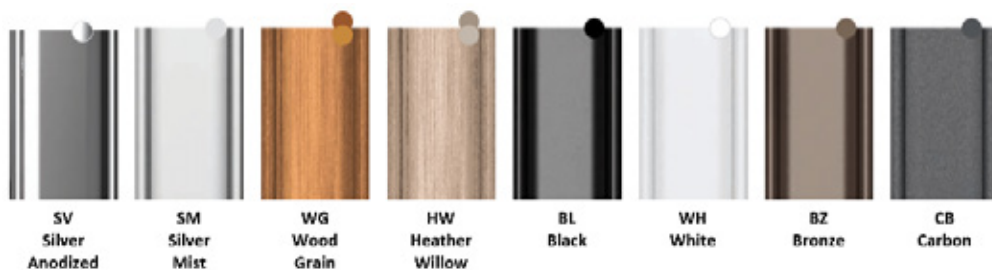

FEATURES

- 316 cast solid stainless steel crank handle and axle.
- 1/2" fiberglass ribs and struts for maximum strength and flexibility.
- 1.5" diameter center pole with a 1/8" aluminum wall thickness provides incredible strength and durability.
- Stainless steel grommets attach the canopy securely to the frame.
- Modular design.
- Stainless steel hardware throughout.

BASE OPTIONS

- UB100RSM aluminum shell (page 60) | UB70RD resin coated concrete (page 60) | UB50RD resin coated concrete (page 60)
- UB75SQ steel plate (page 60) | UBBD camlock (page 63) | UBG24RSM galvanized steel (page 61) | UBG30RSM galvanized steel (page 61)

# G-Series Fiberglass Market umbrellas

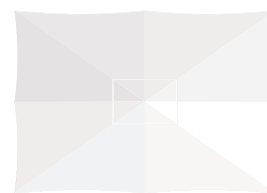
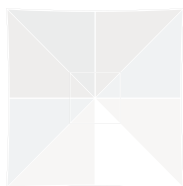
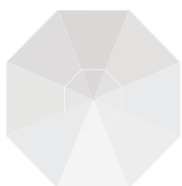

## AVAILABLE FRAME SIZES

U13F: 13' OCTAGON

U10F 10' SQUARE

U8511F: 8.5' x11' RECTANGLE

A: height: 115"

A: height: 115"

A: height: 115"

B: clearance: 85"

B: clearance: 87"

B: clearance: 86"

closed clearance: 30"

closed clearance: 25"

closed clearance: 28"

mast diameter: 2"

mast diameter: 2"

mast diameter: 2"

weight: 38 lbs.

weight 36 lbs.

weight 33 lbs.

standard frame finish

● SV silver

fabric color options on page 138



POLISHED SILVER ANODIZED ALUMINUM FINISH



HIGH IMPACT POLYMER JOINTS AND .75" FIBERGLASS RIBS



COMMERCIAL DOUBLE PULLEY SYSTEM

MARINE GRADE CHROME PLATED ALUMINUM FINIALS



Standard: CLASSIC BALL FINIAL



Optional: VERTEX FINIAL

**FEATURES**

Smooth and effortless double pulley system.

.75" diameter fiberglass ribs and struts support this giant canopy, and provides strength and rigidity.

2" diameter single piece aluminum center pole is 3 mm thick, provides incredible strength and durability.

Modular design.

Stainless steel hardware throughout.

Multiple mounting options are available, either semi-permanent or base mounted.

**BASE OPTIONS**

UBG36RSM galvanized steel (page 61) | UBG40RSM galvanized steel (page 62) | UB480 heavy duty wheel (page 62)

UB150RSM aluminum shell (page 61)

# Aluminum Market umbrellas

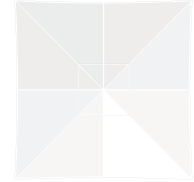
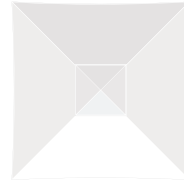
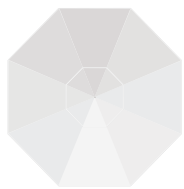

## AVAILABLE FRAME SIZES

U7.5ASV: 7.5' OCTAGON	U9ASV: 9' OCTAGON	U11ASV: 11' OCTAGON	U6.5ASV: 6.5' SQUARE	U7.5SQASV: 7.5' SQUARE
A: height: 94"	A: height: 102"	A: height: 108"	A: height: 102"	A: height: 108"
B: clearance: 70"	B: clearance: 76"	B: clearance: 82"	B: clearance: 76"	B: clearance: 82"
C: upper pole 63"	C: upper pole 69"	C: upper pole 77"	C: upper pole 69"	C: upper pole 77"
D: lower pole: 37"	D: lower pole: 37"	D: lower pole: 37"	D: lower pole: 37"	D: lower pole: 37"
mast diameter: 1.5"	mast diameter: 1.5"	mast diameter: 1.5"	mast diameter: 1.5"	mast diameter: 1.5"
weight: 17 lbs.	weight: 22 lbs.	weight: 24 lbs.	weight: 15 lbs.	weight: 21 lbs.
standard frame finish	SV  silver			
fabric color options on page 138				



POLISHED SILVER ANODIZED ALUMINUM FINISH



HIGH IMPACT POLYMER JOINTS AND EXTRUDED ALUMINUM RIBS



COMMERCIAL PULLEY SYSTEM

MARINE GRADE CHROME PLATED ALUMINUM FINIALS



Standard: VERTEX FINIAL



Optional: CLASSIC BALL FINIAL

**FEATURES**

Smooth and effortless pulley system.

Ergonomically designed ribs maintain the shape and provide added strength.

1.5" diameter, 1/8" wall thickness aluminum center pole provides incredible strength and durability.

Stainless steel hardware throughout.

Multiple mounting options are available, either semi-permanent or base mounted.

**BASE OPTIONS**

UB100RSM aluminum shell (page 60) | UB70RD resin coated concrete (page 60) | UB50RD resin coated concrete (page 60)

UB75SQ steel plate (page 60) | UBBD camlock (page 63) | UBG24RSM galvanized steel (page 61) | UBG30RSM galvanized steel (page 61)

# G-Series Aluminum Market umbrellas

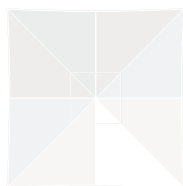
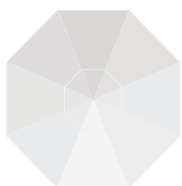

## AVAILABLE FRAME SIZES

U13ASV: 13' OCTAGON

U10ASV: 10' SQUARE

U10ASV: 10' RECTANGLE

A: height: 115"

A: height: 115"

A: height: 115"

B: clearance: 85"

B: clearance: 87"

B: clearance: 86"

closed clearance: 20"

closed clearance: 23"

closed clearance: 23"

mast diameter: 2"

mast diameter: 2"

mast diameter: 2"

weight: 38 lbs.

weight 36 lbs.

weight 33 lbs.

standard frame finish

SV  silver

fabric color options on page 138



POLISHED SILVER ANODIZED ALUMINUM FINISH



HIGH IMPACT POLYMER JOINTS AND EXTRUDED ALUMINUM RIBS



COMMERCIAL DOUBLE PULLEY SYSTEM

MARINE GRADE CHROME PLATED ALUMINUM FINIALS



Standard: VERTEX FINIAL



Optional: CLASSIC BALL FINIAL

**FEATURES**

Smooth and effortless double pulley system.

Ergonomically designed ribs maintain the shape and provide added strength.

2" diameter single piece aluminum center pole is 3 mm thick, provides incredible strength and durability.

Stainless steel hardware throughout.

Multiple mounting options are available, either semi-permanent or base mounted.

**BASE OPTIONS**

UBG36RSM galvanized steel (page 61) | UBG40RSM galvanized steel (page 62) | UB480 heavy duty wheel (page 62)

UB150RSM aluminum shell (page 61)

# Bolt-Down umbrellas

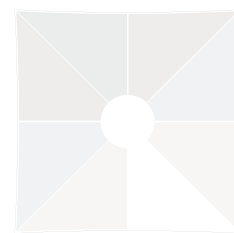
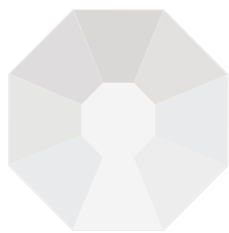

## AVAILABLE FRAME SIZES

UBD16R: 16' OCTAGON

UBD13SQ: 13' SQUARE

A: open height: 126"

A: open height: 126"

B: closed height: 168"

B: closed height: 168"

C: clearance: 98"

C: clearance: 96"

D: crank clearance: 43"

D: closed clearance: 52"

E: mast diameter: 4"

mast diameter: 4"

weight: 260 lbs.

E: weight: 220 lbs.

standard frame finish

SM  silver mist

fabric color options on page 138





TELESCOPING MAST



DOUBLE REINFORCED JOINTS



EXTRUDED ALUMINUM MAST

## FEATURES

As the telescoping cranks down, the top portion of the mast rises, allowing you to completely close the umbrella without having to move any furniture placed underneath.

4" diameter aluminum center pole with four internal strength channels, combined with the extruded aluminum ribs provide exceptional support and strength.

For easier installation of an umbrella this large, the mounts to a hinged spigot. This allows for the umbrella mast to be placed onto the spigot while the unit is on its side, prior to raising it to an upright position.

Reinforced grommets paired with an ultra-durable woven nylon wrap prevent the chance of fabric tearing from the frame.

Engineered to withstand 50-60 MPH sustained winds.

Stainless steel hardware throughout.

Please consult a licensed professional for in-ground or surface mounting installations.

## BASE OPTIONS

UB550 heavy duty (page 62) | UBINGF (page 63) in-ground mount | UB20DP direct surface (page 63)

# Cantilever umbrellas

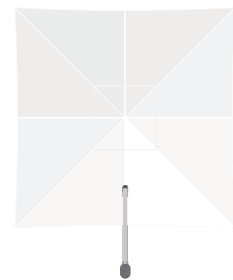
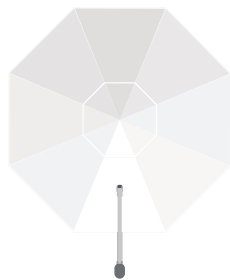

## AVAILABLE FRAME SIZES

UC13R: 13' OCTAGON

UC10SQ: 10' SQUARE

A: height: 110"

A: height: 112"

B: clearance: 82"

B: clearance: 82"

C: open depth: 163"

C: open depth: 135"

closed clearance: 30"

closed clearance: 27"

mast diameter: 3.3" x 5"

mast diameter: 3.3" x 5"

weight: 140 lbs.

weight: 120 lbs.

frame finish

SM  silver mist

fabric color options on page 138

special feature: wind stabilizer bars and black polyester protective cover included.



INFINITY TILT

EXTRUDED ALUMINUM ON ALL  
CRITICAL JOINTS

EXTRUDED ALUMINUM MAST

## FEATURES

Full 360° rotation, combined with the Infinity Tilt system, allows for countless tilt angles, providing hours of maximum shade regardless of the position of the sun.

The crank lift is built for commercial use, yet designed for smooth and effortless operation in any environment.

The mast and all critical joints are extruded aluminum, ensuring unmatched strength and durability.

Engineered to withstand 35 MPH winds. Included wind stabilizer kit increases by 5 MPH.

Stainless steel hardware throughout.

Please consult a licensed professional for in-ground or surface mounting installations.

## BASE OPTIONS

UBG40R555 galvanized steel (page 62) | UB550 heavy duty (page 62) | UB12DP direct surface (page 63)

UBINGF in-ground mount (page 63)

# Umbrella bases



UB50RD | resin coated concrete base for use with umbrella tables

weight | 50 lbs.

diameter | 16"

height | 7"

stem heights | n/a

stem diameter | 1.5"

finish | SM ● silver mist | BL ● black | BZ ● bronze | WH ● white



UB75SQ | steel plate base for stand alone umbrellas

weight | 75 lbs.

dimension | 24 x 24"

height | .5"

stem height | 16"

stem diameter | 1.5"

finish | SM ● silver mist | BL ● black | BZ ● bronze | WH ● white

features | wheels for easy transport, can be secured directly to surface  
*not guaranteed in salt air*



UB70RD | resin coated concrete base for use with umbrella tables

weight | 70 lbs.

diameter | 20"

height | 3.5"

stem height | 8"

stem diameter | 1.5"

finish | WH ● white | SM ● silver mist | BL ● black | BZ ● bronze

features | resin coated, concrete filled. 2 piece base, secondary weight ring fits onto base



UB100RSM | aluminum shell base

weight | 100 lbs.

diameter | 24"

height | 4"

stem heights | 8" for tables | 18" for stand alone umbrellas

stem diameter | 1.5"

finish | SM ● silver mist

features | concrete filled, wheels



UB150RSM | aluminum shell base

weight | 150 lbs.

diameter | 30"

height | 4"

stem height | 18" for stand alone umbrellas

stem diameters | 1.5" / 2"

finish | SM ● silver mist

features | concrete filled, wheels

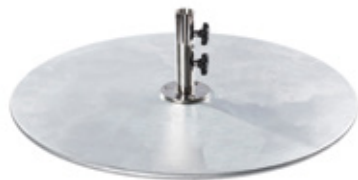

UBG24RSM | galvanized steel plate base

weight | 70 lbs.

diameter | 24"

base height | .5"

stem height | 8" for tables

stem diameters | 1.5"

finish | SM ● silver mist

feature | can stack up to 3 of any G-Plates for increased weight and footprint

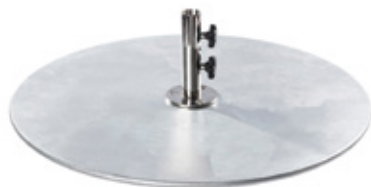

UBG30RSM | galvanized steel plate base

weight | 100 lbs.

diameter | 30"

base height | .5"

stem height | 18" for stand alone umbrellas

stem diameters | 1.5"

finish | SM ● silver mist

feature | can stack up to 3 of any G-Plates for increased weight and footprint

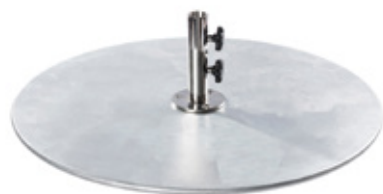

UBG36RSM | galvanized steel plate base

weight | 150 lbs.

diameter | 36"

base height | .5"

stem height | 18" for stand alone umbrellas

stem diameters | 1.5" / 2"

finish | SM ● silver mist

feature | can stack up to 3 of any G-Plates for increased weight and footprint

# Umbrella bases



UBG40RSM | galvanized steel plate base

weight | 185 lbs.

diameter | 40"

base height | .5"

stem heights | 18" for stand alone umbrellas

stem diameters | 1.5" / 2"

finish | SM ● silver mist

feature | can stack up to 3 of any G-Plates for increased weight and footprint



UBG40R555 | galvanized steel plate stack

weight | 555 lbs.

diameter | 40"

base height | 2"

finish | SM ● silver mist

features | triple 40G stack is a required base option for the Cantilever, all 3 plates bolt together, spigot mounts to top plate



UB480 | heavy duty wheel base (minimum weight required 480 lbs and ships empty, pavers not included)

weight | 80 lbs.

dimension | 33 x 34"

height | 10.5" with wheels | 6.5" w/o wheels

finish | SM ● silver mist

features | Holds three 16" pavers per quadrant (12 total pavers). Minimum paver weight per quadrant must be 105 lbs. (35 lbs. per paver) | for 2" diameter pole G-series umbrellas



UB550 | heavy duty base

weight | 550 lbs.

dimension | 45 x 45"

height | 5"

finish | SM ● silver mist

features | galvanized steel frame, smooth aluminum lid housing pavers, bolt-down or cantilever spigot mounts directly to universal deck plate on lid



UB12DP | direct surface mounting plate for cantilever

weight | 12 lbs.

diameter | 12"

height | 5"

finish | BL ● black

features | direct surface mounting deck plate, can be mounted to concrete or wood deck or any stable solid surface

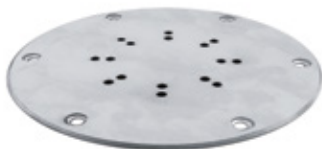

UB20DP | direct surface mounting plate for bolt-down

weight | 20 lbs.

diameter | 20"

height | .5"

finish | SM ● silver mist

features | direct surface mounting deck plate, can be mounted to concrete, wood deck, or any stable solid surface



UBBD | camlock surface mount

weight | 9 lbs.

stem height | 18"

plate diameter | 4"

stem diameter | 1.5"

finish | SM ● silver mist

features | Direct surface mounting plate. Concrete or wood deck or any stable solid surface. Stem can be removed for storage. (HARDWARE NOT INCLUDED)



UBINGF | in-ground mount for bolt-down & cantilever

weight | 18 lbs.

diameter | 8"

height | 20"

finish | SM ● silver mist

features | in-ground mounting in soil, clay or concrete



Industrial seating





## Chester series



NP

## PRODUCT INFORMATION

102C+wood+R-SB side chair dimensions | h34 | w18.25 | sh18 | sd18

102B+wood+R-SB barstool dimensions | h41 | w18.25 | sh30 | sd15

frame finish BL ● black

wood seat and back colors FH ● farmhouse | KP ● knotty pine | VW ● vintage walnut

materials sand black powder coat finish

# Barrick series



## PRODUCT INFORMATION

2165C+seat+SM side chair dimensions | h32.5 | w17 | sh17.5 | sd16.5

2165B+seat+SM barstool dimensions | h42.5 | w17 | sh29 | sd16.5

frame finish sand black power coat | clear coat

standard vinyl colors BL ● black

wood seat and back colors ASH ● autumn ash

materials welded 18 gauge steel

features upgraded vinyl and textile upholstery options found on pages 125 - 133 | C.O.M.





## NV series



## PRODUCT INFORMATION

JS44CASH-AASB side chair dimensions | h33.5 | w19.25 | sh19 | sd17

JS44HASH-AASB counter stool dimensions | h40 | w19.25 | sh26 | sd17

JS44BASH-AASB barstool dimensions | h43.5 | w19.25 | sh29.5 | sd17

frame finish SB ● sand black

wood finish AA ● autumn ash

materials solid steel rod | ash veneer wood

seat options wood | upholstered

feature upholstery found on pages 125 - 133 | C.O.M.

# Hamilton series



## PRODUCT INFORMATION

JS10CNTV-NTPL side chair dimensions | h32 | w18 | sh18 | sd16.5

JS10HNTV-NTPL counter stool dimensions | h39 | w18 | sh26 | sd16.5

JS10BNTV-NTPL barstool dimensions | h42 | w18 | sh29 | sd16.5

frame finish PL ● platinum powder coat | SB ● black (not available for JS10HNTV-NTPL)

wood finish NTV ● natural

materials welded steel | powder coat | ash wood veneer

seat options wood | upholstery found on pages 125 - 133 | C.O.M.

# Memphis series



*bench available in SB sand black only.*

## PRODUCT INFORMATION

JS33C+wood+frame	side chair dimensions   h34.5   w17.25   sh18   sd18.5
JS33H+wood+frame	counter stool dimensions   h36.25   w16.5   sh26   sd15.5
JS33B+wood+frame	barstool dimensions   h40.5   w16.5   sh30.25   sd15.5
JS337ASH-SB	bench dimensions   w47.25   sh18   sd14
frame finish	RU ● distressed   SB ● sand black
wood finish	NT ● natural ash   AA ● autumn ash   GR ● gray ash
materials	welded box tube steel   powder coat   ash wood
seat options	wood   upholstery found on pages 125 - 133   C.O.M.



# Lincoln series



## PRODUCT INFORMATION

JS22C+seat+back+CL	side chair dimensions   h31   w16   sh18   sd13   sw15.5
JS200C+seat+CL	backless chair dimensions   h18   w16   sd13   sw15.5
JS22H+seat+back+CL	counter stool dimensions   h39   w18   sh26   sd13   sw15.5
JS200H+seat+CL	backless counter stool dimensions   h26   w18   sd13   sw15.5
JS22B+seat+back+CL	barstool dimensions   h42   w17.5   sh29   sd13   sw15.5
JS200B+seat+back+CL	backless barstool dimensions   h29   w17.5   sd13   sw15.5
frame finish	CL ● clear coat
back options	AA ● autumn ash wood   CL ● clear coat stamped steel
seat options	wood   upholstery found on pages 125 - 133   C.O.M.
materials	welded steel   powder coat   ash wood
feature	steel swivel glides with nylon floor protectors

## Henry series



## PRODUCT INFORMATION

JS88C+wood+frame side chair dimensions | h33.5 | w19 | sh17.5 | sd15.5 | sw16

JS88H+wood+frame counter stool dimensions | h38 | w19 | sh26 | sd15.5 | sw16

JS88B+wood+frame barstool dimensions | h41 | w19 | sh29 | sd15.5 | sw16

JS800H +wood+frame backless counter stool dimensions | h26 | w15.5 | sd15.5

JS800B+wood+frame backless barstool dimensions | h30.5 | w15.5

frame finish RU ● distressed | SB ● sand black

seat options wood | upholstery found on pages 125 - 133 | C.O.M.

seat wood finish NT ● natural ash | AA ● autumn ash

materials welded tubular steel | ash wood

## Lima Clear Coat series



TRENT



## PRODUCT INFORMATION

2160C+seat+CL side chair dimensions | h32.5 | w17.25 | sh17.5 | sd16.5

2160H+seat+CL counter stool dimensions | h39.5 | w17 | sh27 | sd16.5

2160B+seat+CL barstool dimensions | h42.5 | w17.25 | sh29 | sd16.5

2510H+seat+CL backless counter stool dimensions | h27 | w16 | sd15.75

2510B+seat+CL backless barstool dimensions | h30 | w16 | sd15.75

frame finish CL ● clear coat

standard vinyl colors BLV ● black

wood seat colors ASH ● autumn ash | NTW ● natural | CHW ● light cherry | MHW ● mahogany  
WAW ● walnut | BLW ● black

relic seat colors AW ○ antique wash | CS ● chestnut | FH ● farmhouse | KP ● knotty pine |  
RC ● rustic copper | VW ● vintage walnut

materials welded steel construction | powder coat

features upgraded vinyl options found on pages 125 - 133 | C.O.M.



# Nash series



## PRODUCT INFORMATION

JS55CASH-AA+frame	side chair dimensions   h34   w22   sh18   sd16.5   sw15
JS55BASH-AA+frame	barstool dimensions   h43.75   w22   sh29.5   sd16.5   sw15
frame finish	SB ● sand black
wood finish	AA ● autumn ash veneer
materials	welded tubular steel   veneer seat and back
feature	stackable (side chair only)



Steel seating

## Lima series



## PRODUCT INFORMATION

2160C+seat+SB	ladder back side chair dimensions   h33   w17.25   sh17.5   sd16.5
2160B+seat+SB	ladder back barstool dimensions   h43.75   w17.25   sh30.5   sd16.5
2160S+seat+SB	ladder back swivel barstool dimensions   h42.5   w17.25   sh30.5   sd16.5
frame finish	sand black powder coat
standard vinyl colors	BLV ● black
wood seat colors	ASH ● autumn ash   NTW ● natural   CHW ● light cherry   MHW ● mahogany WAW ● walnut   BLW ● black
relic seat colors	AW ○ antique wash   CS ● chestnut   FH ● farmhouse   KP ● knotty pine   RC ● rustic copper VW ● vintage walnut
materials	welded 18 gauge steel
features	upgraded vinyl options found on pages 125 - 133   C.O.M.

## Lima Silver Mist series



## PRODUCT INFORMATION

2160C+seat+SM side chair dimensions | h33 | w17.25 | sh17.5 | sd16.5

2160B+seat+SM barstool dimensions | h43.75 | w17.25 | sh30.5 | sd16.5

frame finish silver mist powder coat

standard vinyl colors BLV ● black

wood seat colors ASH ● autumn ash | NTW ● natural | CHW ● light cherry | MHW ● mahogany  
WAW ● walnut | BLW ● black

relic seat colors AW ○ antique wash | CS ● chestnut | FH ● farmhouse | KP ● knotty pine  
RC ● rustic copper | VW ● vintage walnut

materials welded 18 gauge steel

features upgraded vinyl options found on pages 125 - 133 | C.O.M.



## Dale series



## PRODUCT INFORMATION

2150C+seat+back+SB	vener wood back side chair dimensions   h33   w17.25   sh17.5   sd16.5
2150B+seat+back+SB	vener wood back barstool dimensions   h43.75   w17.25   sh30.5   sd16.5
2150S+seat+back+SB	vener wood back swivel barstool dimensions   h42.5   w17.25   sh30.5   sd16.5
frame finish	sand black powder coat
standard vinyl colors	BLV ● black
vener wood seat and back colors	NTW ● natural   CHW ● light cherry   MHW ● mahogany   WAW ● walnut
materials	welded 18 gauge steel
features	upgraded vinyl options found on pages 125 - 133   C.O.M.

## Espy series



## PRODUCT INFORMATION

2151C+seat+back+SB	slotted veneer wood back side chair dimensions   h33   w17.25   sh17.5   sd16.5
2151B+seat+back+SB	slotted veneer wood back barstool dimensions   h43.75   w17.25   sh30.5   sd16.5
2151S+seat+back+SB	slotted veneer wood back swivel barstool dimensions   h42.5   w17.25   sh30.5   sd16.5
frame finish	sand black powder coat
standard vinyl colors	BLV ● black
veneer wood seat and back colors	NTW ● natural   CHW ● light cherry   MHW ● mahogany   WAW ● walnut
materials	welded 18 gauge steel
features	upgraded vinyl options found on pages 125 - 133   C.O.M.

## Darby series



## PRODUCT INFORMATION

2152C+seat+back+SB	circle veneer wood back side chair dimensions   h33   w17.25   sh17.5   sd16.5
2152B+seat+back+SB	circle veneer wood back barstool dimensions   h43.75   w17.25   sh30.5   sd16.5
2152S+seat+back+SB	circle veneer wood back swivel barstool dimensions   h42.5   w17.25   sh30.5   sd16.5
frame finish	sand black powder coat
standard vinyl colors	BLV ● black
veneer wood seat and back colors	NTW ● natural   CHW ● light cherry   MHW ● mahogany   WAW ● walnut
materials	welded 18 gauge steel
features	upgraded vinyl options found on pages 125 - 133   C.O.M.

# Meghan series



NP

## PRODUCT INFORMATION

JS33CM+seat+SB	side chair dimensions   h34.5   w17.25   sh18   sd18.5
JS33CHM+seat+SB	counter stool dimensions   h36.25   w16.5   sh26   sd15.5
JS33BM+seat+SB	barstool dimensions   h40.5   w16.5   sh30.25   sd15.5
JS337M+seat+SB	bench dimensions   h18   w47.25   sh18   sd14
frame finish	sand black power coat
materials	welded 18 gauge steel
features	upholstery options found on pages 125 - 133   C.O.M.

# Polk series



## PRODUCT INFORMATION

2161C+seat+SB	perforated back side chair dimensions   h33   w17.25   sh17.5   sd16.5
2161B+seat+SB	perforated back barstool dimensions   h43.75   w17.25   sh30.5   sd16.5
frame finish	sand black powder coat
standard vinyl colors	BLV ● black
wood seat colors	ASH ● autumn ash   NTW ● natural   CHW ● light cherry   MHW ● mahogany WAW ● walnut   BLW ● black
relic seat colors	AW ○ antique wash   CS ● chestnut   FH ● farmhouse   KP ● knotty pine   RC ● rustic copper VW ● vintage walnut
materials	welded 18 gauge steel
features	upholstery options found on pages 125 - 133   C.O.M.

## Akrin series



## PRODUCT INFORMATION

2130C+seat+SB	cross back side chair dimensions   h33   w17.25   sh17.5   sd16.5
2130B+seat+SB	cross back barstool dimensions   h43.75   w17.25   sh30.5   sd16.5
2130S+seat+SB	cross back swivel barstool dimensions   h42.5   w17.25   sh30.5   sd16.5
frame finish	sand black powder coat
standard vinyl colors	BLV ● black
wood seat colors	ASH ● autumn ash   NTW ● natural   CHW ● light cherry   MHW ● mahogany WAW ● walnut   BLW ● black
relic seat colors	AW ○ antique wash   CS ● chestnut   FH ● farmhouse   KP ● knotty pine   RC ● rustic copper VW ● vintage walnut
materials	welded 18 gauge steel
features	upholstery options found on pages 125 - 133   C.O.M.

## Troy series



## PRODUCT INFORMATION

2090C+seat+SB	slat back side chair dimensions   h33   w17.25   sh17.5   sd16.5
2090B+seat+SB	slat back barstool dimensions   h43.75   w17.25   sh30.5   sd16.5
frame finish	sand black powder coat
standard vinyl colors	BLV ● black
wood seat colors	ASH ● autumn ash   NTW ● natural   CHW ● light cherry   MHW ● mahogany WAW ● walnut   BLW ● black
relic seat colors	AW ○ antique wash   CS ● chestnut   FH ● farmhouse   KP ● knotty pine   RC ● rustic copper VW ● vintage walnut
materials	welded 18 gauge steel
features	upholstery options found on pages 125 - 133   C.O.M.

## Trent series



## PRODUCT INFORMATION

2510B+seat+SB metal barstool dimensions | h30 | w16 | sd15.75

2510B+seat+CL metal barstool dimensions | h30 | w16 | sd15.75

2510H seat+CL metal counter stool dimensions | h27 | w16 | sh27 | sd15.75

frame finish CL ● clear coat | SB ● sand black

standard vinyl colors BLV ● black

wood seat colors ASH ● autumn ash | NTW ● natural | CHW ● light cherry | MHW ● mahogany  
WAW ● walnut | BLW ● black

relic seat colors AW ○ antique wash | CS ● chestnut | FH ● farmhouse | KP ● knotty pine | RC ● rustic copper  
VW ● vintage walnut

materials welded 18 gauge steel

features upholstery options found on pages 125 - 133 | C.O.M.



# Bristol series



## PRODUCT INFORMATION

4301C+seat+SB

side chair dimensions | h33 | w17.25 | sh17.5 | sd17

4301B+seat+SB

barstool dimensions | h43.75 | w17.25 | sh30.5 | sd16.5

4301S+seat+SB

swivel barstool dimensions | h42.5 | w17.25 | sh30.5 | sd16.5

frame finish

sand black powder coat

materials

welded 18 gauge steel

features

upholstery options found on pages 125 - 133 | C.O.M.



Wood seating

## Emma series



## PRODUCT INFORMATION

ZWC22+finish+seat	side chair dimensions   h32.5   w17   sh17.75   sd16   sw17
ZWB22+finish+seat	barstool dimensions   h42.5   w17   sh30   sd14.75   sw16
frame finish	DW ● dark walnut   NT ● natural
seat options	wood   graded vinyls found on pages 125 - 133   C.O.M.
custom options	wood reveal edge with upholstery on seat and back
materials	european beechwood
feature	modern mid-century design   european manufactured

# Emma Cane Back series



## PRODUCT INFORMATION

ZWC22+finish+seat side chair dimensions | h32.5 | w17 | sh17.75 | sd16 | sw17

ZWB22+finish+seat barstool dimensions | h42.5 | w17 | sh30 | sd14.75 | sw16

frame finish NT ● natural | DW ● dark walnut

seat options wood | graded vinyls found on pages 125 - 133 | C.O.M.

custom options wood reveal edge | upholstered seat edge

materials european beechwood | synthetic cane back

feature modern mid-century design | european manufactured

# Sofia series



Upcharge applies for ribbed upholstered seat.

## PRODUCT INFORMATION

ZWC88+finish+seat side chair dimensions | h33.5 | w18 | sh18.75 | sd15.5 | sw15.5

ZWB88+finish+seat barstool dimensions | h42 | w18 | sh30 | sd15.5 | sw16

frame finish BW ● black walnut | CS ● vintage

seat options wood | graded vinyls found on pages 125 - 133 | C.O.M.

materials european beechwood

feature steamed bentwood | european manufactured

## Dover series



## PRODUCT INFORMATION

ZWC305+finish+seat	side chair dimensions   h32.5   w18   sh18.5   sd17   sw17.5
ZWB305+finish+seat	barstool dimensions   h41   w16.5   sh30   sd16.25   sw16.25
frame finish	DW ● dark walnut   BL ● black stain
seat options	wood   graded vinyls found on pages 125 - 133   C.O.M.
materials	european beechwood
feature	barstool—brass footrest   satin nickel finish available upon request   european manufactured

# Giulia series



## PRODUCT INFORMATION

ZWC66+finish+seat

side chair dimensions | h30 | w17 | sh18 | sd15 | sw15

ZWB66+finish+seat

barstool dimensions | h42.5 | w17 | sh30 | sd14.75 | sw15

frame finish

DW ● dark walnut | NT ● natural | BL ● black stain

seat options

wood | graded vinyls found on pages 125 - 133 | C.O.M.

materials

european beechwood

feature

space saving design | european manufactured





## Aston series



## PRODUCT INFORMATION

ZWC304+finish+seat	side chair dimensions   h31.75   w17.25   sh18   sd16   sw17.25
ZWB304+finish+seat	barstool dimensions   h43.75   w17.25   sh30.75   sd16   sw17.25
frame finish	DW ● dark walnut   BL ● black stain
seat options	wood   graded vinyls found on pages 125 - 133   C.O.M.
materials	european beechwood
feature	brass footrest   satin nickel finish available upon request   european manufactured

## Berkeley series



## PRODUCT INFORMATION

ZWC101+finish+seat	ladder back side chair dimensions   h34   w17.5   sh18.5   sd17
ZWB101+finish+seat	ladder back barstool dimensions   h44   w17.5   sh29.5   sd16
frame finish	DM ● dark mahogany   NT ● natural   BL ● black stain   DW ● dark walnut
wood seat finishes	DM ● dark mahogany   NT ● natural   BL ● black stain   DW ● dark walnut
relic seat colors	AW ○ antique wash   CS ● chestnut   FH ● farmhouse   KP ● knotty pine   RC ● rustic copper   VW ● vintage walnut
standard vinyl colors	BLV ● black
seat options	wood   graded vinyls found on pages 125 - 133   C.O.M.
materials	european beechwood
feature	brass footrest standard on barstool   satin nickel finish available upon request european manufactured

# Stockton series



## PRODUCT INFORMATION

ZWB680+finish+seat	backless barstool dimensions   h30   w17.25   d15.75   sw16
frame finish	DM ● dark mahogany   NT ● natural   BL ● black stain   DW ● dark walnut
wood seat finishes	DM ● dark mahogany   NT ● natural   BL ● black stain   DW ● dark walnut
relic seat colors	AW ○ antique wash   CS ● chestnut   FH ● farmhouse   KP ● knotty pine   RC ● rustic copper VW ● vintage walnut
standard vinyl colors	BLV ● black
seat option	wood   graded vinyls found on pages 125 - 133   C.O.M.
materials	european beechwood
feature	brass footrest standard on barstool   satin nickel finish available upon request european manufactured



Tables indoor

## Wood Veneer table tops



VN2430 | 24 x 30

VN3030 | 30 x 30

VN3636 | 36 x 36

VN3042 | 30 x 42

VN3048 | 30 x 48

VN3060 | 30 x 60

VN3072 | 30 x 72

VN24 | 24R

VN30 | 30R

VN36 | 36R

VN48 | 48R

finish | AA ● autumn ash | NT ● natural

materials | 1 1/4" thick ash wood edge with ash wood veneer inlay

## Midtown table tops

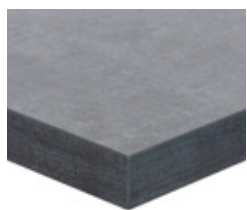
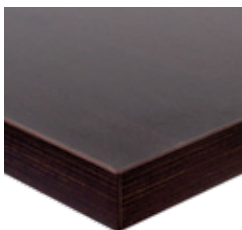

finish code+size | 24 x 24

finish code+size | 24 x 30

finish code+size | 30 x 30

finish code+size | 36 x 36

finish code+size | 30 x 42

finish code+size | 30 x 48

finish code+size | 30 x 60

finish code+size | 30 x 72

finish code+size | 24R

finish code+size | 30R

finish code+size | 36R

finish code+size | 45R

finish | CNT ● textured concrete | EST ● textured espresso  
 SO ● textured sawmill oak | DW ● textured driftwood  
 FF ● textured frosted slate | WH ○ white

materials | 1 7/8" edge with honeycomb core | melamine surface with matching ABS edge

# Relic table tops



thickness+finish code+size | 24 x 30

thickness+finish code+size | 30 x 30

thickness+finish code+size | 36 x 36

thickness+finish code+size | 30 x 42

thickness+finish code+size | 30 x 48

thickness+finish code+size | 30 x 60

thickness+finish code+size | 30 x 72

thickness+finish code+size | 30R

thickness+finish code+size | 36R

thickness+finish code+size | 48R

thickness | 1" or 2" thick MDF core

materials | melamine | matching PVC edge

finish | RC ● rustic copper | FH ● farmhouse | KP ● knotty pine  
 CS ● chestnut | AW ● antique wash |  
 VW ● vintage walnut





# Wireless Charger flat mount



## PRODUCT INFORMATION

NP-KEY	magnetic key to remove batteries   w180mm
NPC-BATT	spare battery with usb-a & usb-c   w140mm
NPC-CHARGE	battery charging tray and cord *batteries not included   h90mm   w245mm   d185mm



NP

## PRODUCT INFORMATION

NPC-FLATKIT-1	single flat mount starter kit (flat coil, table dock, battery, key & charger tray & installation)
NPC-FLATP	wireless charger flat pack (flat coil, table dock, battery & installation)



# Wireless Charger on-top mount



NP

## PRODUCT INFORMATION

NPC-TOPKIT-1	single on-top starter kit (on-top coil, table dock, battery, key & charger tray)
NPC-TOPKIT-4	4 pack on-top starter kit (4 on-top coils, 4 table docks, 4 batteries, 1 key, & 1 charger tray)
NPC-TOPP	wireless charger-on-top pack (on top coil, table dock & battery)

## Atlas bases



NP

Ships KD

## PRODUCT INFORMATION

TBA2-3048 dining height | h28.5 (for a 30x48 top)

TBA2-3060 dining height | h28.5 (for a 30x60 top)

TBA2-3072 dining height | h28.5 (for a 30x72 top)

TBA2-3048T bar height | h40.5 (for a 30x48 top)

TBA2-3060T bar height | h40.5 (for a 30x60 top)

TBA2-3072T bar height | h40.5 (for a 30x72 top)

frame finish BL ● sand black

materials steel | powder coat

# Urban bases



NP

Ships KD

## PRODUCT INFORMATION

TBU2-3048 dining height | h28.5 (for a 30x48 top)

TBU2-3060 dining height | h28.5 (for a 30x60 top)

TBU2-3072 dining height | h28.5 (for a 30x72 top)

TBU2-3048T bar height | h40.5 (for a 30x48 top)

TBU2-3060T bar height | h40.5 (for a 30x60 top)

TBU2-3072T bar height | h40.5 (for a 30x72 top)

frame finish BL ● sand black

materials steel | powder coat

# Indoor bases



## Jaxon



BXS-2020 | 20" cross base | dining height

BXS-2020T | 20" cross base | bar height

BXS-2424 | 24" cross base | dining height

BXS-2424T | 24" cross base | bar height

top plate | 1 1/4" bolt on plate

finish | sand black

materials | stamped steel

column | 3" square

feature | unique vertical design



## Jaxon

BXS-0024 | 24" end base | dining height  
2-pc set

BXS-0024T | 24" end base | bar height  
2-pc set

top plate | 1 1/4" bolt on plates

finish | sand black

materials | stamped steel

column | 3" square

feature | unique vertical design

## Uptown



LP-18R | 18" round base | dining height

LP-18RT | 18" round base | bar height

LP-20R | 20" round base | dining height

LP-20RT | 20" round base | bar height

LP-24R | 24" round base | dining height

LP-24RT | 24" round base | bar height

top plate | 1 1/4" bolt on plate

finish | sand black | white

materials | stamped steel

column | 3" round

features | thin profile design



## Uptown



LP-18SQ | 18" square base | dining height

LP-18SQT | 18" square base | bar height

LP-20SQ | 20" square base | dining height

LP-20SQT | 20" square base | bar height

LP-24SQ | 24" square base | dining height

LP-24SQT | 24" square base | bar height

top plate | 1 1/4" bolt on plate

finish | sand black | white

materials | stamped steel

column | 3" square

features | thin profile design



# Indoor bases



## Uptown

- LP-0024SQ | 24" end base | dining height | 2-pc set
- LP-0024SQ | 24" end base | bar height | 2-pc set
- top plate | 11 3/4" bolt on plate
- finish | sand black | white
- materials | stamped steel
- column | 3" square
- feature | thin profile design

## Indoor



- STB+size+height | round base
- base diameter | 18 | 22 | 30
- finish | sand black
- materials | stamped steel
- top plate | welded | BP bolt on plate
- dining | C counter | T bar height
- 3" or 4" diameter columns (3" column welded plate 7.8 x 7.8" | 3" or 4" column bolt-on plate 11.8 x 11.8")

## Indoor foot ring



- STB+base size+TFR | base with foot ring
- available in all cross and round sizes
- finish | sand black
- materials | stamped steel
- top plate | welded
- feature | 3" or 4" diameter columns (3" column welded plate 7.8 x 7.8")

## Niles



- PHTB500 | round base | dining height
- PHTB500T | round base | bar height
- base diameter | 20
- finish | sand black
- materials | cast iron
- feature | ornate base plate

## Indoor



- ST+size+height | cross base
- base spread | 22 x 22 | 24 x 30 | 30 x 30  
36 x 36
- finish | sand black
- materials | stamped steel
- top plate | welded | BP bolt on plate
- dining | C counter | T bar height
- 3" or 4" diameter columns (3" column welded plate 7.8 x 7.8" | 3" or 4" column bolt-on plate 11.8 x 11.8")

## Indoor



- STB-0022 | dining height (sold separately)
- STB-0022CBP | counter height (sold separately)
- STB-0022T | bar height (sold separately)
- base spread | 5 x 22 | 2 required per top
- finish | sand black
- materials | stamped steel
- top plate | welded | BP bolt on plate
- feature | ADA capabilities
- (3" column welded plate 7.8 x 7.8" | 3" column bolt-on plate 11.8 x 11.8")

# Indoor bases



## Corner Post leg

TB-SQ2 | 2" square post | dining height  
(sold as set of 4)

TB-SQ3 | 3" square post | dining height  
(sold as set of 4)

finish | sand black

materials | steel and powder coat

feature | ADA capabilities



## NV corner leg

NV4L-SB | dining height  
(sold as set of 4)

NV4L-SBC | counter height  
(sold as set of 4)

NV4L-SBT | bar height  
(sold as set of 4)

finish | black

materials | solid rod steel

feature | matches NV chair series  
ADA capabilities



## Cantilever

TB-C22 | bracket 22" long

TB-C33 | bracket 33" long

TB-P125 | pin leg 1.25

finish | glossy black powder coat  
black wrinkle (pin leg)

materials | welded steel

feature | wall mounting



## Bolt-down base

TB-BD | base | dining height

TB-BDT | base | bar height

TB-BDC | base | counter height

finish | black wrinkle

materials | welded steel

feature | cover plate



## I-beam

JSTB3636+height | 36 x 36

JSTB3048+height | 30 x 48

JSTB3648+height | 36 x 48

JSTB3060+height | 30 x 60

JSTB3660+height | 36 x 60

JSTB3072+height | 30 x 72

JSTB3672+height | 36 x 72

finish | black powder coat

materials | steel

features | electric outlet capability | frame manufactured  
to conceal hardwiring  
(Outlets & wiring not included. Cover plates included for unused outlet cutouts.)

dining height BL or bar height BLT

# Indoor / Outdoor bases



## Alpha indoor | outdoor

PHTBBD+finish | bolt-down base

PHTBBDT+finish | bolt-down base

finish | SS ■ stainless | BL ● black | SV ● silver

materials | 304 stainless steel

dining or bar height

feature | ADA capabilities | bolt down



## Elite indoor | outdoor

PHTB+size+SQSS | square | dining height

PHTB+size+SQSST | square | bar height

base spread | 18 x 18 | 24 x 24

top plate | 11.8" x 11.8"

materials | 304 brushed stainless steel

dining or bar height



## Elite indoor | outdoor

PHTB+size+RSS | round | dining height

PHTB+size+RSST | round base bar height

base diameter | 18 | 24

top plate | 11.8" x 11.8"

materials | 304 brushed stainless steel

dining or bar height



## Elite indoor | outdoor

PHTB0024SS | dining height (sold as pair)

PHTB0024SST | bar height (sold as pair)

base spread | 4 x 24

top plate | 11.8" x 11.8"

materials | 304 brushed stainless steel

feature | ADA capabilities



## Elite double column indoor | outdoor

PHTB1630SS | dining height

PHTB1630SST | bar height

base spread | 16 x 30

top plate | 11.8" x 11.8"

materials | 304 brushed stainless steel

# Trash receptacles



TE4622CS | trash receptacle

finish | CS ● chestnut

material | melamine | MDF

feature | holds standard 35 gallon plastic container, size 19" w x 19" d x 27" h

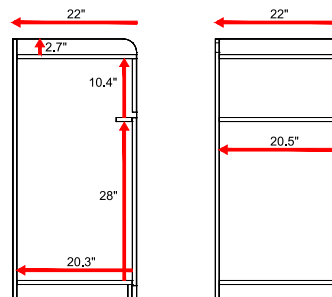

TE4622VW | trash receptacle

finish | VW ● vintage walnut

material | melamine | MDF

feature | holds standard 35 gallon plastic container, size 19" w x 19" d x 27" h



TE4622KP | trash receptacle

finish | KP ● knotty pine

material | melamine | MDF

feature | holds standard 35 gallon plastic container, size 19" w x 19" d x 27" h



# Trash receptacles



TE4622RC | trash receptacle

finish | RC ● rustic copper

material | melamine | MDF

feature | holds standard 35 gallon plastic container, size 19"w x 19"d x 27"h

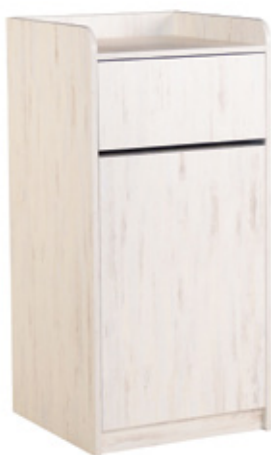

TE4622AW | trash receptacle

finish | AW ● antique wash

material | melamine | MDF

feature | holds standard 35 gallon plastic container, size 19"w x 19"d x 27"h



TE4622FH | trash receptacle

finish | FH ● farmhouse

material | melamine | MDF

feature | holds standard 35 gallon plastic container, size 19"w x 19"d x 27"h

# Server stations – single door

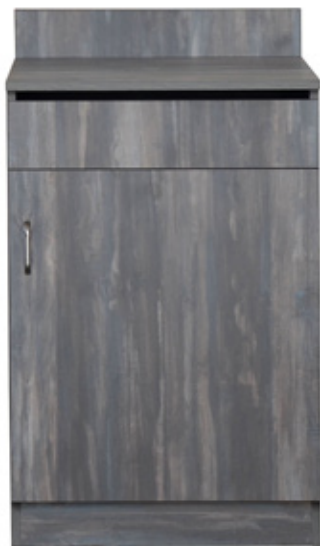

WS4024CS | server station

finish | CS ● chestnut

material | melamine | MDF

feature | drawer and inside shelf

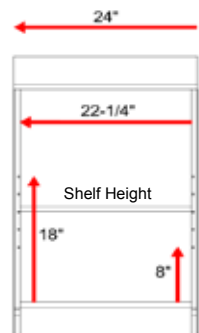
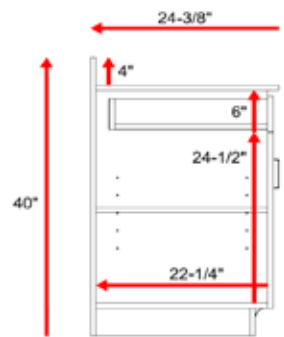

WS4024VW | server station

finish | VW ● vintage walnut

material | melamine | MDF

feature | drawer and inside shelf



WS4024KP | server station

finish | KP ● knotty pine

material | melamine | MDF

feature | drawer and inside shelf

# Server stations – single door



WS4024RC | server station

finish | RC ● rustic copper

material | melamine | MDF

feature | drawer and inside shelf

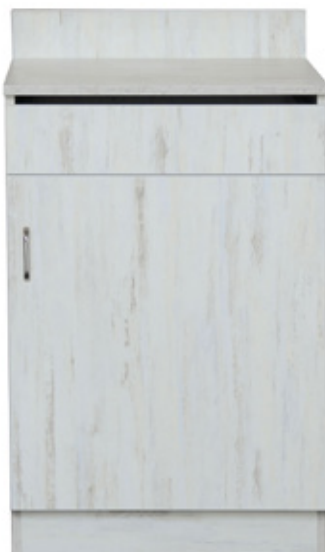

WS4024AW | server station

finish | AW ● antique wash

material | melamine | MDF

feature | drawer and inside shelf



WS4024FH | server station

finish | FH ● farmhouse

material | melamine | MDF

feature | drawer and inside shelf

# Server stations – double door



WS4047CS | server station

finish | CS ● chestnut

material | melamine | MDF

feature | 2 drawers and 2 inside shelves

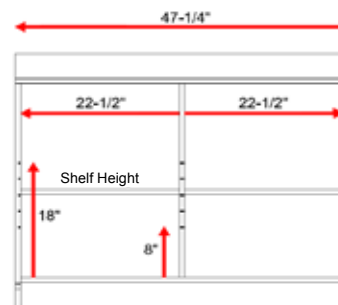
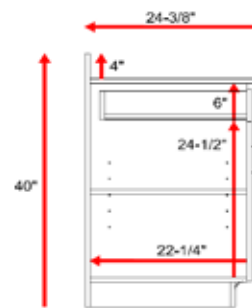

WS4047VW | server station

finish | VW ● vintage walnut

material | melamine | MDF

feature | 2 drawers and 2 inside shelves



WS4047KP | server station

finish | KP ● knotty pine

material | melamine | MDF

feature | 2 drawers and 2 inside shelves

# Server stations – double door



WS4047RC | server station

finish | RC ● rustic copper

material | melamine | MDF

feature | 2 drawers and 2 inside shelves



WS4047AW | server station

finish | AW ● antique wash

material | melamine | MDF

feature | 2 drawers and 2 inside shelves



WS4047FH | server station

finish | FH ● farmhouse

material | melamine | MDF

feature | 2 drawers and 2 inside shelves

# Seat cushions



NP

## Tahiti outdoor

PHXSC	Chair cushion dimensions   w16   d17.5
PHXAC	Armchair cushion dimensions   w17   d18.5
PHXSB	Barstool cushion dimensions   w15.25   d17.5
materials	Genuine Sunbrella® Fabric; Foam inserts
features	Custom manufactured in the US; Commercial quality & construction; Ties attach with Velcro®



NP

## Key West outdoor

PHKC	Chair cushion dimensions   w17.75   d17.75
PHKB	Barstool cushion dimensions   w17   d16.75
materials	Genuine Sunbrella® Fabric; Foam inserts
features	Custom manufactured in the US; Commercial quality & construction; Ties attach with Velcro®

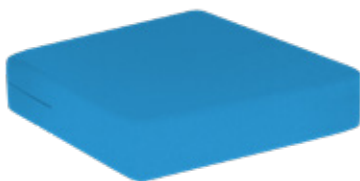
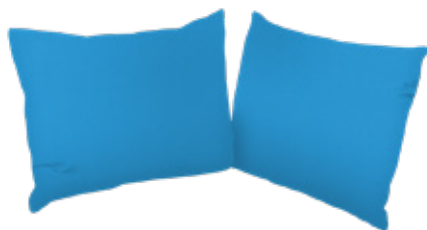

NP

## Cayman outdoor

PHPCSEAT-CU(+)	Sofa corner cushion dimensions   w26.75   d21
PHPCBACK-2PL(+)	Sofa corner pillow dimensions   w26.75   d19.5
PHPMSEAT-CU(+)	Sofa middle cushion dimensions   w25.75   d21
PHPMBACK-PL(+)	Sofa middle pillow dimensions   w25.75   d19.5
PHPASEAT-CU(+)	Armchair cushion dimensions   w27.5   d21
PHPABACK-PL(+)	Armchair pillow dimensions   w27.5   d19.5
materials	Genuine Sunbrella® Fabric; Foam inserts
features	Custom manufactured in the US; Commercial quality & construction

# Seat cushions

## Aruba outdoor



PH5101-CU(+)	Left/right cushion dimensions   w25.5   d19.5
PH5101-CU(+)	Wide middle cushion dimensions   w25.5   d19.5
PH5101M-CU(+)	Middle cushion dimensions   w21.5   d19.5
PH5101C-CU(+)	Corner cushion dimensions   w19.5   d19.5
PH5102-CU(+)	Armchair cushion dimensions   w21.5   d20
PH5106-CU(+)	Ottoman cushion dimensions   w25   d25
materials	Genuine Sunbrella® Fabric; Foam inserts
features	Custom manufactured in the US; Commercial quality & construction



# Seat cushions



## Belmar outdoor

PH6101-CU+	Left/right cushion dimensions   w25.5   d19.5
PH6101C-CU+	Middle cushion dimensions   w25.5   d19.5
PH6102-CU+	Armchair cushion dimensions   w25.5   d19.5
PH6106-CU+	Ottoman cushion dimensions   w27.5   d25.5
materials	Genuine Sunbrella® Fabric; Foam inserts
features	Custom manufactured in the US; Commercial quality & construction



NP

## Maui outdoor

PHV-CU+	Cushion dimensions   w15.5   d15.5
materials	Genuine Sunbrella® Fabric; Foam inserts
features	Custom manufactured in the US; Commercial quality & construction; Ties attach with Velcro®



## Cancun outdoor

PH7100-CU+	Cushion dimensions   w48   d17.5
materials	Genuine Sunbrella® Fabric; Foam inserts
features	Custom manufactured in the US; Commercial quality & construction



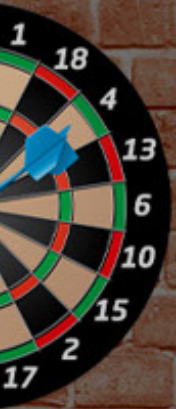





# Quick Ship Vinyl



Black

For products on pages 67, 75, 79-83, 85-88, 98 & 99.

## Steel seating wood seat options



Natural



Light Cherry



Autumn Ash

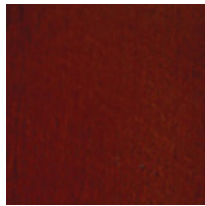

Mahogany

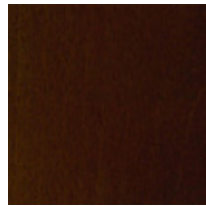

Walnut

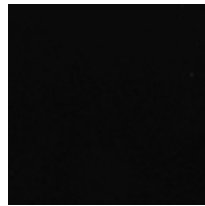

Black

For products on pages 75, 79-83, 85-88.  
Available on select items. Inquire for more information.

## Relic seat options

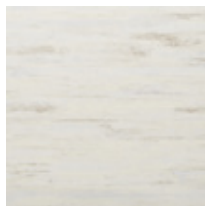

Antique Wash

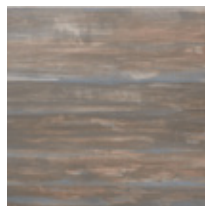

Chestnut



Farmhouse

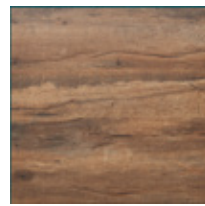

Knotty Pine

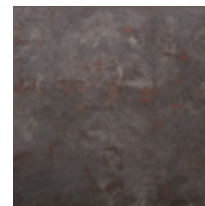

Rustic Copper

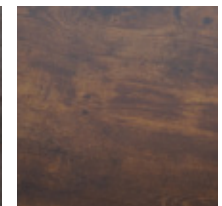

Vintage Walnut

# Grade 2 Vinyl



American Beauty  
VNS-001



Aqua Green  
VNS-002



Avocado  
VNS-003



Black Walnut  
VNS-004



Blue Ridge  
VNS-005



Bright Yellow  
VNS-006



Burgundy  
VNS-007



Chocolate Chip  
VNS-008



Claret  
VNS-009



Concord  
VNS-010



Ebony  
VNS-013



Forest  
VNS-016



Georgia Clay  
VNS-017

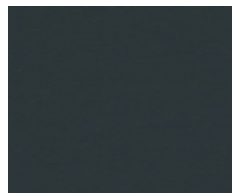

Graphite  
VNS-018



Indigo  
VNS-020

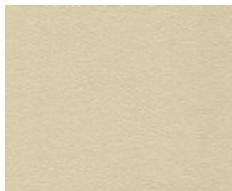

Ivory  
VNS-021



Kelly Green  
VNS-023

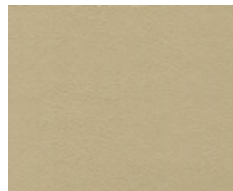

Mushroom  
VNS-025

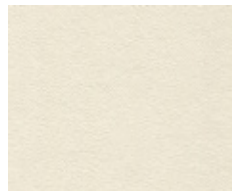

Pearl  
VNS-027



Royal Blue  
VNS-029

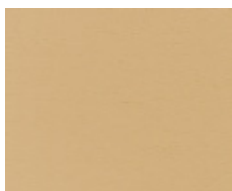

Sand  
VNS-030

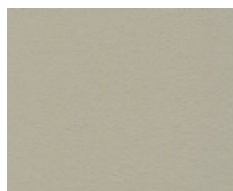

Silver Grey  
VNS-031

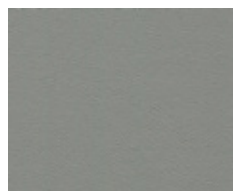

Silver Surf  
VNS-032

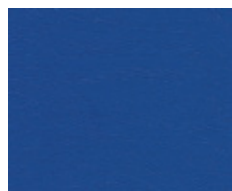

Sky Blue  
VNS-033

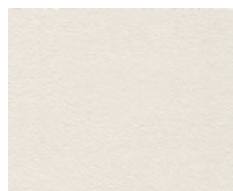

Super White  
VNS-034



Tan  
VNS-035

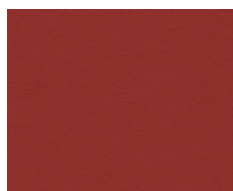

Tea Rose  
VNS-037



Tiger Lily  
VNS-038



Yellow Gold  
VNS-040

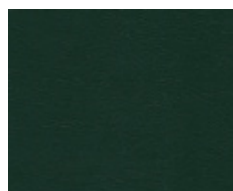

Yew Green  
VNS-041

# Grade 3 Vinyl



MOD-2001  
FARRO

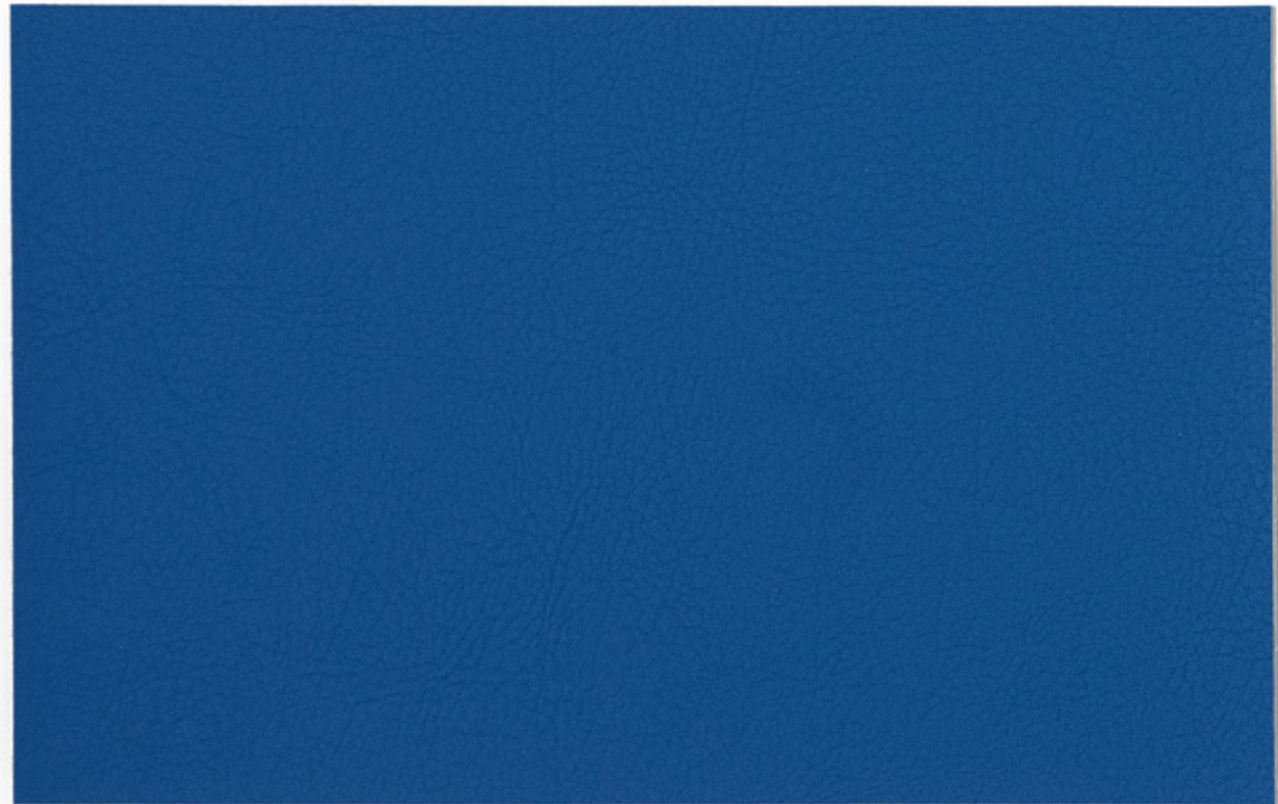

MOD-2002  
BLUEBIRD

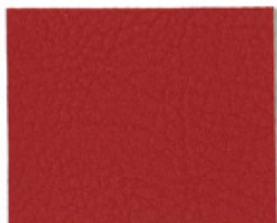

MOD-2003  
TANDOORI



MOD-2004  
MANDARIN



MOD-2005  
CHAMPAGNE

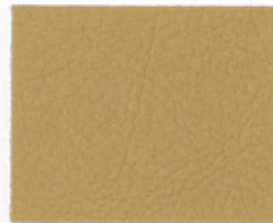

MOD-2006  
MEDALLION



MOD-2007  
FRESH

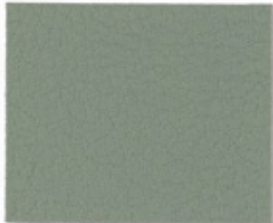

MOD-2008  
SEAGRASS



MOD-2009  
SANCTUARY



MOD-2010  
CYPRESS



MOD-2011  
AZURE

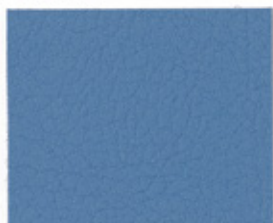

MOD-2012  
ERIE

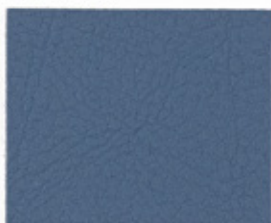

MOD-2013  
TITAN

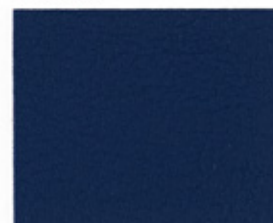

MOD-2014  
INK

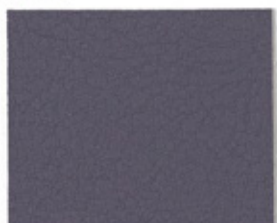

MOD-2015  
HAZE

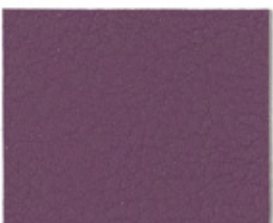

MOD-2016  
BOHEMIAN

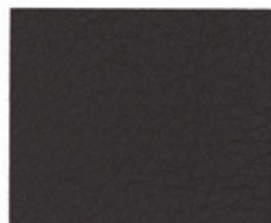

MOD-2017  
TWILIGHT

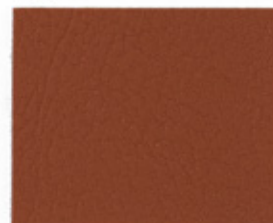

MOD-2018  
COGNAC

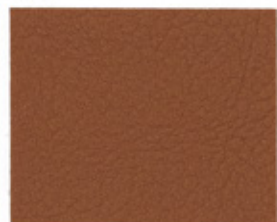

MOD-2019  
NUTMEG

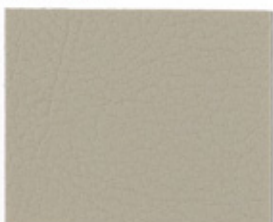

MOD-2020  
PEARL

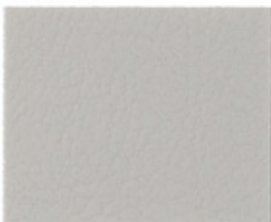

MOD-2021  
AUSTER

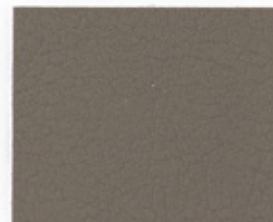

MOD-2022  
ELEPHANT

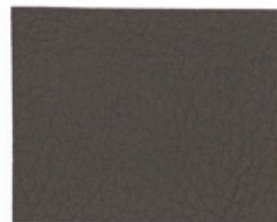

MOD-2023  
COCOA



MOD-2024  
SIDEWALK

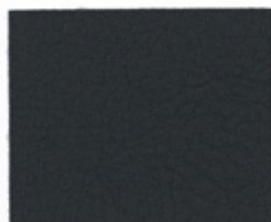

MOD-2025  
GRAPHITE

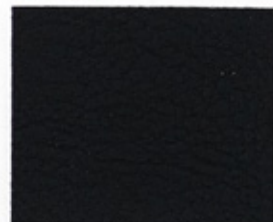

MOD-2026  
BLACK

# Grade 4 Vinyl



Gauze STT-007



Cotton STT-005



Sheer STT-019



Parchment STT-015



Burlap STT-002



Hemp STT-009



Spindel STT-020



Tobacco STT-022





Linen STT-013



Oxford STT-014

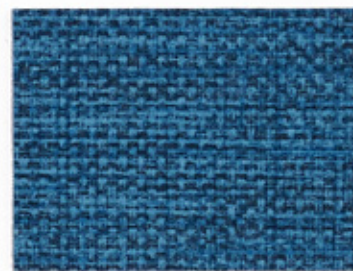

Chambray STT-004



Rafia STT-016

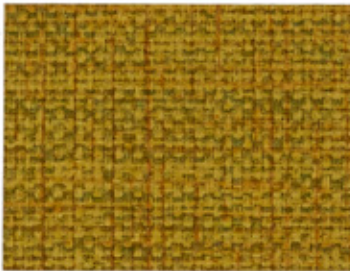

Grasscloth STT-008

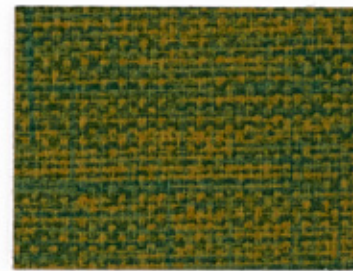

Bamboo STT-001

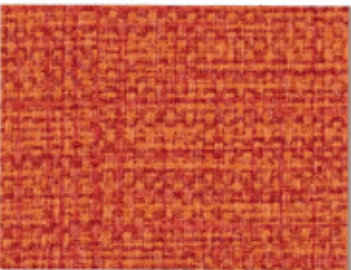

Sari STT-017



Henna STT-010



Cadmium STT-003

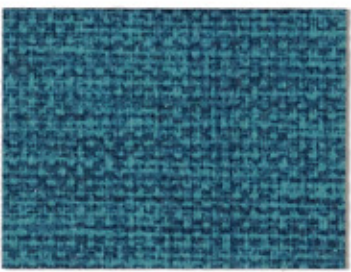

Scuba STT-018

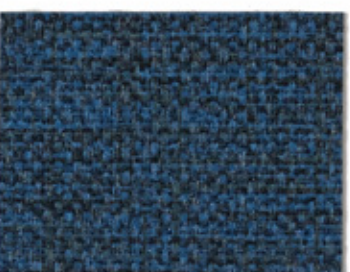

Indigo STT-011



Tapestry STT-021



Worsted STT-023



Flannel STT-006



Kona STT-012

# Grade 4 Vinyl - Whisper



WHI-2174  
PAVESTONE

NEW



WHI-2170  
POWDER

NEW



WHI-2171  
PEARL

NEW



WHI-2117  
BONE

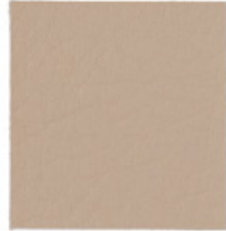

WHI-2172  
SAND

NEW



WHI-2173  
FARRO

NEW



WHI-2118  
CAMEL



WHI-2141  
CASHEW



WHI-2150  
FAWN



WHI-2120  
ANTELOPE



WHI-2121  
CAPPUCCINO



WHI-2142  
COGNAC



WHI-2123  
LUGGAGE



WHI-2183  
SADDLE

NEW



WHI-2125  
CINNAMON



WHI-2182  
AUBURN

NEW



WHI-2181  
COASTAL

NEW



WHI-2136  
CERULEAN



WHI-2137  
NAVY



WHI-2175  
TERRACOTTA

NEW

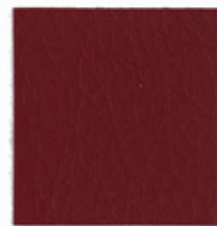

WHI-2126  
BORDEAUX



WHI-2184  
SLATE

NEW



WHI-2161  
MALLARD



WHI-2163  
INDIGO



WHI-2124  
SALSA



WHI-2165  
MOLTEN



WHI-2138  
ELEPHANT



WHI-2180  
EMERALD

NEW



WHI-2177  
ISLET

NEW



WHI-2176  
BREEZE

NEW



WHI-2162  
PARADISE



WHI-2155  
STORM



WHI-2179  
HERBAL

NEW



WHI-2178  
SILVER LEAF

NEW



WHI-2134  
PATINA



WHI-2160  
SASSAFRAS



WHI-2152  
MAHOGANY



WHI-2157  
FOG



WHI-2186  
WOLF GREY

NEW



WHI-2154  
PEWTER



WHI-2185  
FOSSIL

NEW

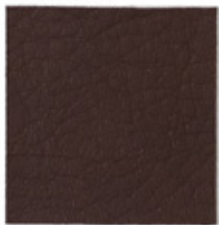

WHI-2153  
TRUFFLE



WHI-2143  
ESPRESSO



WHI-2139  
CHARCOAL



WHI-2140  
BLACK

# Grade 4 Vinyl

 <b>Adobe White</b> US 394	 <b>Ivory</b> US 500	 <b>Coral Sand</b> US 502	 <b>Froth</b> US 501	 <b>Surf</b> US 513	 <b>Fjord Blue</b> US 517	 <b>Bristol Blue</b> US 515	 <b>Pink</b> US 503	
 <b>Alabaster</b> US 396	 <b>Parchment</b> US 385	 <b>Shell</b> US 402	 <b>Sand</b> US 384	 <b>Dusty Jade</b> US 417	 <b>Turquoise</b> US 419	 <b>Dutch Blue</b> US 518	 <b>Mauve</b> US 415	
 <b>Taupe</b> US 410	 <b>Bone</b> US 404	 <b>Peach</b> US 406	 <b>Vicuna</b> US 401	 <b>Northwoods</b> US 528	 <b>Grotto</b> US 426	 <b>Wedgewood</b> US 414	 <b>Tea Rose</b> US 416	
 <b>Putty</b> US 403	 <b>Bisque</b> US 409	 <b>Rose</b> US 412	 <b>Doe</b> US 519	 <b>Lilac</b> US 508	 <b>Sage</b> US 526	 <b>Space Blue</b> US 353	 <b>Rouge Red</b> US 505	
 <b>Gray Moss</b> US 525	 <b>Dewberry</b> US 424	 <b>Sunset</b> US 521	 <b>Camel</b> US 387	 <b>Crocus</b> US 433	 <b>Artichoke</b> US 527	 <b>Royal</b> US 354	 <b>Raspberry</b> US 362	
 <b>Dove</b> US 413	 <b>Woodrose</b> US 423	 <b>Paprika</b> US 370	 <b>Oak</b> US 421	 <b>Deep Violet</b> US 511	 <b>Olive Green</b> US 529	 <b>Regimental Blue</b> US 345	 <b>Dark Cherry</b> US 507	
 <b>Greystone</b> US 425	 <b>Chestnut</b> US 375	 <b>British Tan</b> US 365	 <b>Terra Cotta</b> US 376	 <b>Grape</b> US 509	 <b>Alpine</b> US 530	 <b>Imperial Blue</b> US 432	 <b>American Beauty</b> US 360	
 <b>Gunmetal</b> US 392	 <b>Bronze</b> US 523	 <b>Gingersnap</b> US 369	 <b>Cinnamon</b> US 377	 <b>Sangria</b> US 506	 <b>Forest</b> US 344	 <b>Sky Blue</b> US 516	 <b>Tomato</b> US 358	
 <b>Blue Ridge</b> US 427	 <b>Mocha</b> US 381	 <b>Cinnabar</b> US 520	 <b>Goldenrod</b> US 324	 <b>Plum</b> US 361	 <b>Yew Green</b> US 350	 <b>Capri Blue</b> US 514	 <b>Rosalee</b> US 504	
 <b>Graphite</b> US 429	 <b>Rustic Brown</b> US 522	 <b>Claret</b> US 357	 <b>Golden Corn</b> US 524	 <b>Dark Purple</b> US 512	 <b>Emerald</b> US 343	 <b>China Green</b> US 434	 <b>Mandarin Orange</b> US 372	
 <b>Black</b> US 393	 <b>Espresso</b> US 383	 <b>Burgundy</b> US 364	 <b>Sun Yellow</b> US 322	 <b>Concord</b> US 510				

For products on pages 67, 70-75, 79-89, 91-95, 97-99.

# Grade 4 Tailor Made Textile Upholstery

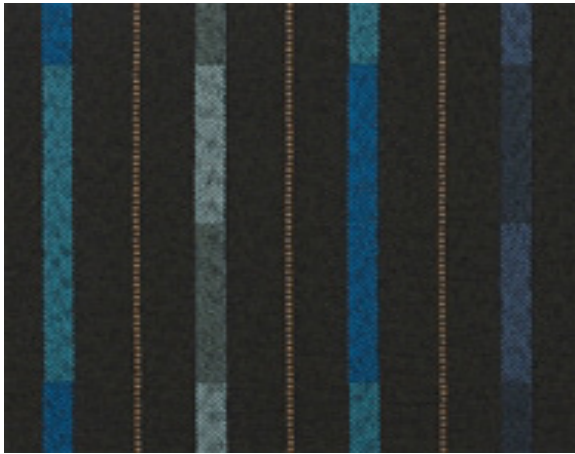

Cabana 2358-412



City Lights 2358-200

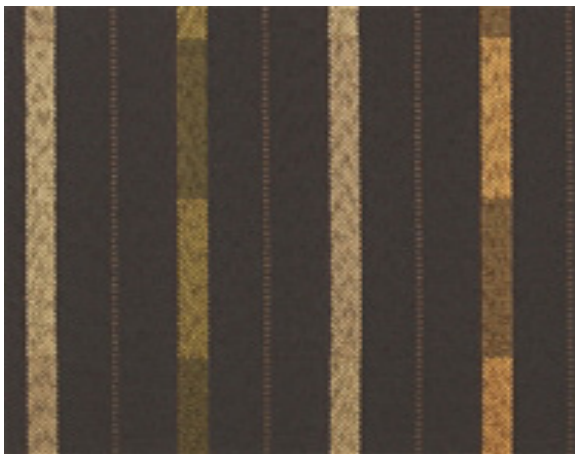

Marshland 2358-414

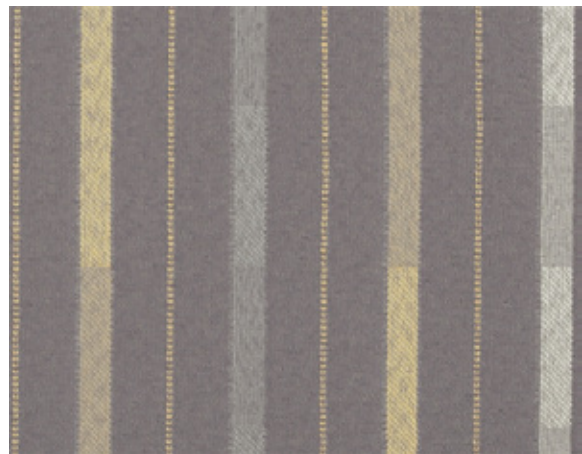

Nightshade 2358-134



Horizon 2358-410

# Sunbrella® Sofa Cushion Canvas

Aruba, Belmar, & Cayman series

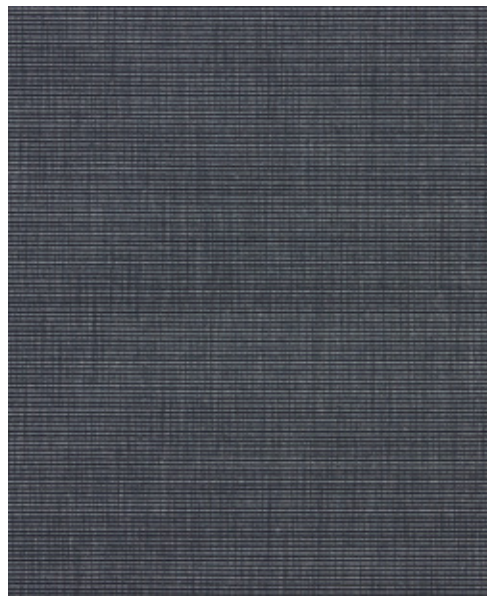

**Twilight**  
14089-0000



**Glacier**  
5428-0000



**Mineral Blue**  
5420-0000



**Sky Blue**  
5424-0000



**Cyan**  
56105-0000



**Sapphire Blue**  
5452-0000



**Air Blue**  
5410-0000

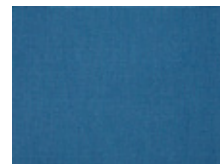

**Regatta**  
5493-0000



**Pacific Blue**  
5401-0000



**Capri**  
5426-0000



**Haze**  
14059-0054



**Abyss**  
14066-0000



**Aruba**  
5416-0000

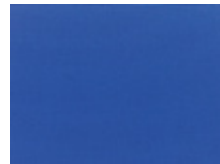

**True Blue**  
5499-0000

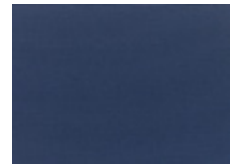

**Navy**  
5439-0000

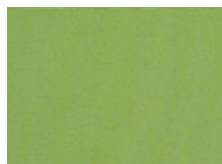

**Ginkgo**  
54011-0000



**Teal**  
5456-0000



**Spa**  
5413-0000



**Forest Green**  
5446-0000

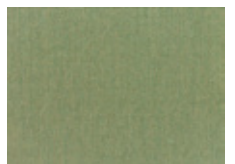

**Fern**  
5487-0000

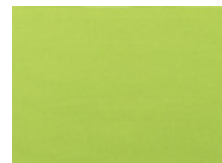

**Macaw**  
5429-0000

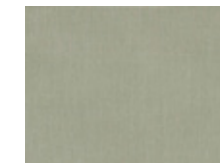

**Seasalt**  
14106-0000

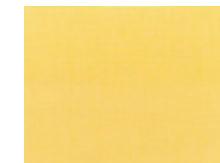

**Buttercup**  
5438-0000



**Sunflower**  
5457-0000



**Wheat**  
5414-0000

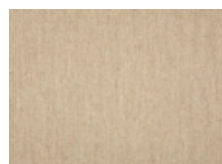

**Fawn**  
57015-0000

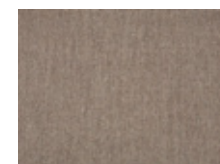

**Mushroom**  
14067-0000

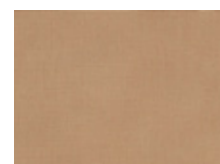

**Raffia**  
14107-0000

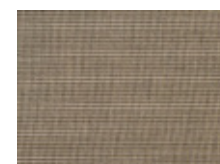

**Flint**  
14090-0000

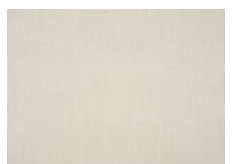

**Cloud**  
57012-0000

# Sunbrella® Sofa Cushion Canvas

Aruba, Belmar, & Cayman series



**Tangerine**  
5406-0000



**Tuscan**  
5417-0000



**Rust**  
54010-0000

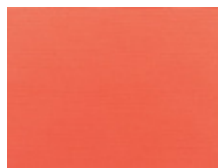

**Melon**  
5415-0000



**Tamale**  
14086-0000

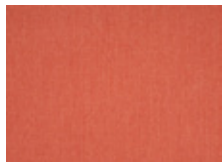

**Persimmon**  
57013-0000

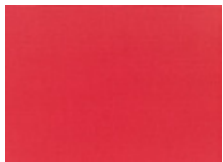

**Logo Red**  
5477-0000



**Jockey Red**  
5403-0000



**Hot Pink**  
5462-0000



**Terracotta**  
5440-0000

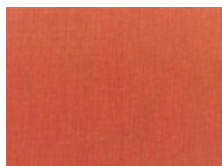

**Brick**  
5409-0000

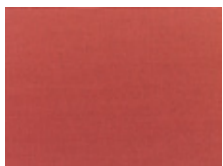

**Henna**  
5407-0000



**Burgundy**  
5436-0000



**Heather Beige**  
5476-0000



**Camel**  
5468-0000

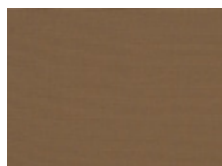

**Cocoa**  
5425-0000

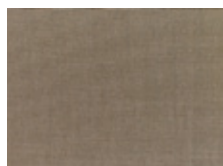

**Taupe**  
5461-0000

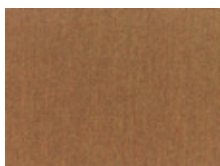

**Teak**  
5488-0000



**Bay Brown**  
5432-0000

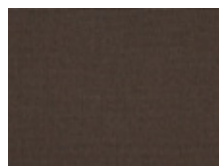

**Java**  
57014-0000

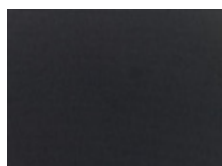

**Raven Black**  
5471-0000

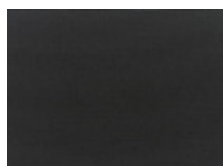

**Black**  
5408-0000

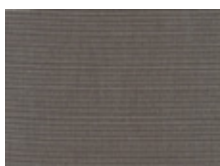

**Coal**  
5489-0000

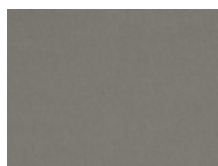

**Charcoal**  
54048-0000

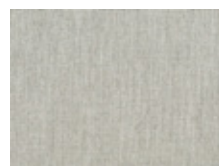

**Granite**  
5402-0000

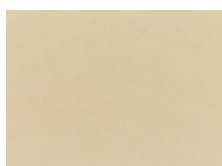

**Antique Beige**  
5422-0000

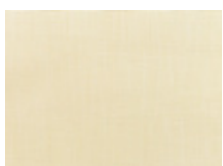

**Vellum**  
5498-0000

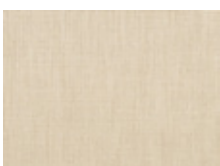

**Flax**  
5492-0000

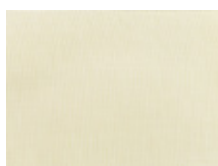

**Birds Eye**  
5472-0000

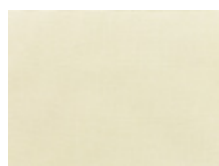

**Canvas**  
5453-0000

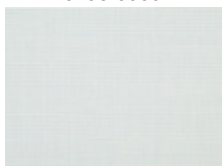

**Skyline**  
14091-0000

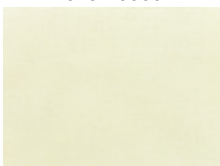

**Natural**  
5404-0000

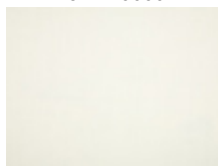

**White**  
57003-0000



Please contact us about our custom cushion capabilities.

# Sunbrella® Sofa Cushion Fabric Patterns

Aruba, Belmar, & Cayman series



Palma 68 Renew



Palma 09 Bahama

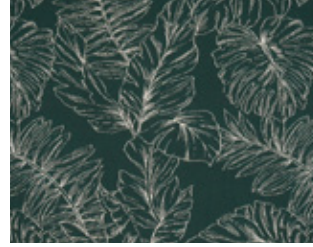

Palma 20 Canopy



Nema 62 Pampas



Nema 41 Lazuli



Nema 55 Newsprint



Nema 49 Moonlight



Nema 83 Teak

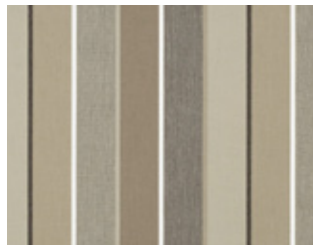

Milano Char 56079-0000



Milano Cobalt 56080-0000



*Please contact us about our custom cushion capabilities.*





# 9 oz Umbrella Canvas

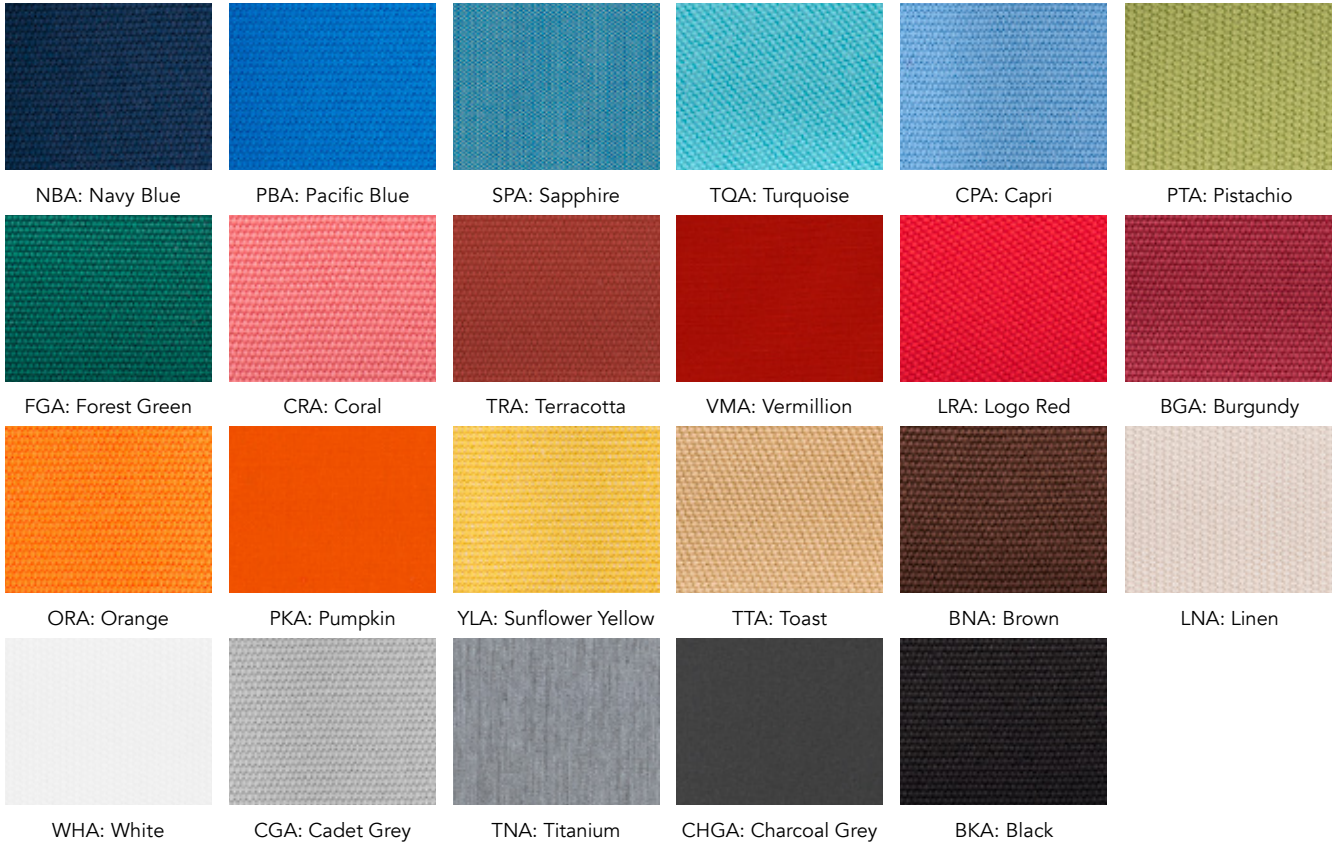

STRIPES REPEATING PATTERN: 6.4"



# Umbrella base guide by application

Umbrella Bases	Umbrella sizes											
	Market umbrellas - 1 1/2" Pole					G-series - 2" pole			Cantilever		Bolt-down	
	6.5'	7.5SQ'	7.5'	9'	11'	13'	10'	8.5x11'	10SQ'	13R'	13SQ'	16R'
UB50RD	T	T	T	T	T							
UB70RD	T	T	T	T	T							
UB75SQ	S		S	S								
UB100RSM	TS	T	TS	TS	T							
UB150RSM	S	S	S	S	S	S	S	S				
UBG24RSM	T	T	T	T	T							
UBG30RSM	S	S	S	S	S							
UBG36RSM	S	S	S	S	S	S	S	S				
UBG40RSM	S	S	S	S	S	S	S	S				
UBG40R555									S	S		
UB480						S	S	S				
UB550									S	S	S	S
UB12DP									S	S		
UB20DP											S	S
UBBD	S	S	S	S	S							
UBINGF									S	S	S	S

T = Table use      S = Stand-alone      TS = Table use or Stand-alone

**T** Table use: Indicates the base is suitable for use beneath a table. It is not recommended as a stand-alone base option.

**S** Stand-alone: Indicates the base is recommended as a stand-alone base option. It is not recommended as a table use base option.

**TS** Table use or Stand-alone: Indicates the base is suitable for use beneath a table or as a stand-alone base option.

Table use bases require an 8" stem option and stand-alone bases require an 18" stem option.

# Indoor base sizing guide

Table Base	Table Size										
	24"/30" Round	36" Round	45"/48" Round	24" Square	30" Square	36" Square	24x30"	30x42"	30x48"	30x60"	30x72"
See outdoor table base guide for more base options											
Jaxon End base set								•	•	•	•
Jaxon 20x20 Cross bases	•			•	•		•				
Jaxon 24x24 Cross bases		•				•					
Atlas 30x48 A-Frame								•			
Atlas 30x60 A-Frame									•		
Atlas 30x72 A-Frame											•
Urban 30x48 Loop Frame								•			
Urban 30x60 Loop Frame									•		
Urban 30x72 Loop Frame											•
Niles 20" Round Bases	•	•		•	•		•		2	2	2
Stamped Steel End bases								2	2	2BP	2BP
Stamped Steel 22x22 Cross bases	•			•	•		•				
Stamped Steel 24x30 Cross bases								•			
Stamped Steel 30x30 Cross bases		•				•					
Stamped Steel 36x36 Cross bases			•								
Stamped Steel 18" Round bases	•			•	•		•		2	2BP	2BP
Stamped Steel 22" Round bases		•			•	•				2BP	2BP
Stamped Steel 30" Round bases			•								
TB-BD Bolt-Down bases	•	•		•	•		•	2	2		
TB-C22 22" Cantilever Bracket				•	•		•				
TB-C33 33" Cantilever Bracket Also requires TB-P125 if marked PL (Pin Leg)						•		•	PL	PL	PL
NV corner leg sets NV4L				•	•	•	•	•	•	•	•
TB-SQ corner leg sets 2" or 3"				•	•	•	•	•	•	•	•
Uptown End base set								•	•	•	•
Uptown 18" Round or Square bases	•			•	•		•		2	2	2
Uptown 20" Round or Square bases		•			•						
Uptown 24" Round or Square bases		•	•			•					

2 = two bases required per top / 2BP = two Bolt-On plate bases required per top  
PL = TB-C33 & TB-P125 are both required.

I-BEAM Bases	36" Square	30x48"	30x60"	30x72"	36x48"	36x60"	36x72"
JSTB3636BL & JSTB3636BLT	•						
JSTB3048BL & JSTB3048BLT		•					
JSTB3060BL & JSTB3060BLT			•				
JSTB3072BL & JSTB3072BLT				•			
JSTB3648BL & JSTB3648BLT					•		
JSTB3660BL & JSTB3660BLT						•	
JSTB3672BL & JSTB3672BLT							•

# Outdoor base sizing guide

Table base & top name <small>Outdoor bases can also be used with indoor tops</small>	Table top size											Umbrella Compatible
	24" Round	30 & 32" Round	36" Round	42" Round	48" Round	24" Square	30 & 32" Square	34 & 36" Square	24x30" 24x32"	30x51" 32x48"	30x60" 30x72"	
<b>Alpha Bolt-Down</b> Longport, Seaside, Tribeca	•	•	•			•	•		•	2		
<b>Bali</b> Longport, Seaside, Tribeca	•	•	•			•	•	•	•			
<b>Bali End Base Set</b> Longport, Seaside, Tribeca										•	•	UB
<b>Boca 24" Spread</b> Tribeca*	•	•				•	•		•			
<b>Boca 33" Spread</b> Tribeca*		•	•	•	•		•	•				UB
<b>Boca Trestle</b> Tribeca*										•		
<b>Elite 18" Round</b> Longport, Seaside, Tribeca	•	•				•	•		•	2	2	
<b>Elite 18" Square</b> Longport, Seaside, Tribeca	•	•	•			•	•		•	2	2	
<b>Elite 24" Round</b> Longport, Seaside, Tribeca			•	•	•			•				
<b>Elite 24" Square</b> Longport, Seaside, Tribeca				•	•			•				
<b>Elite End Base Set</b> Longport, Seaside, Tribeca										•	•	UB
<b>Elite Double Column 16x30"</b> Longport, Seaside, Tribeca										•		
<b>Margate 16" Round</b> Longport, Seaside, Tribeca	•					•						
<b>Margate 16" Square</b> Longport, Seaside, Tribeca	•					•			•			
<b>Margate 18" Round or Square</b> Longport, Seaside, Tribeca	•	•				•	•		•			UC
<b>Margate 20" Round</b> Longport, Seaside, Tribeca			•									UC
<b>Margate 20" Square</b> Longport, Seaside, Tribeca			•					•				UC
<b>Margate 24" Round or Square</b> Longport, Seaside, Tribeca				•	•			•				UC

\*Tribeca tops on Boca bases require special drilling

UB = Umbrella Base required / UC = Column holds umbrella / 2 = two bases required per top

# Terms & Conditions

## Orders & Cancellations

All orders, order changes or cancellations must be placed in writing by fax or e-mailed to [orders@bfm1.com](mailto:orders@bfm1.com). Special orders require a 50% deposit. Canceled orders that have been assembled are subject to a minimum 25% restocking charge plus any material and labor charges not covered by the minimum restock charge.

Customers are responsible for any and all costs expended by BFM for changes or cancellations including but not limited to special upholstery, production and labor costs. Custom upholstered/manufactured items such as but not limited to umbrellas, sofa cushions/pillows & seats cannot be canceled once production has started.

## Terms and Conditions

Credit terms are established on an individual basis. Special orders require a 50% deposit. Product not picked up or shipped within 30 days needs to be paid for in full to continue to be held for an additional 30 days. Product held beyond 60 days will incur a 1.5% storage charge per month beginning on the 61st day.

## Returns

Merchandise cannot be returned without a written return authorization. Approved returns are subject to a minimum 25% restocking charge. Freight out and return freight will be the customer's responsibility. Return will be approved upon inspection. If you wish to return your product, simply call 215-289-5411 or email us at

[returns@bfm1.com](mailto:returns@bfm1.com) for a return authorization number (RA). All returns must be in the original condition and packaging. All returns will be subject to a 25% restocking fee.

Please Note: Any product ordered that has been custom built or manufactured includes but is not limited to; umbrellas, sofa cushions/pillows, custom upholstered seats are not returnable.

## Freight & Freight Claims

BFM will ship by our carrier unless instructed otherwise on purchase order. All shipments are FOB our Philadelphia warehouse. PO must specify Prepaid & Add, Third Party or Freight Collect. BFM reserves the right to ship items FOB factory as circumstances may dictate. When the freight leaves our facility it is signed for in good order by the freight carrier. At this point the freight is no longer ours. It is the responsibility of the consignee to inspect the goods upon arrival. In the event there is not time to open cartons and inspect all items, the bill of lading should be signed subject to inspection. If any damage is found, it is the responsibility of the consignee to report the damage to the freight carrier and BFM Seating within 24 hours of receiving shipment. BFM will not be held responsible for carrier delays in delivery or any other circumstances beyond BFM's control.

## Product Care

Product should be inspected on a regular basis for loose screws, glides, cracked or broken welds, cracked laminate, or any other irregularities.

Synthetic Teak: Wash with mild soap and warm water. Metal: Use a damp cloth. For grease and other stains use a combination of mild soap and water and wash thoroughly.

Wood: Coat with hard paste wax every few months for the first year and then as needed thereafter. Liquid spills should

be cleaned up immediately. A liquid wood cleaner/wax product should be used for general cleaning. Do not use any solvents, abrasive or other harsh cleaners.

Upholstery: Vinyls may be cleaned with mild soap and water or vinyl cleaner (do not use any ammonia or chlorine products).

For fabric upholstery verify cleaning procedure with manufacturer of the fabric or check with us.

Laminated Table Tops: Use mild soap and water (do not use any ammonia or chlorine products).

## Warranty

The furniture in this catalog carries the following 1 year limited warranty against defects in construction to the original end user purchaser. Warranty is void if product is not maintained, altered in any fashion, mistreated or misused.

Extent of warranty is to cover workmanship and material of frames and does not cover upholstery, umbrellas or other materials. Other materials are governed by manufacturer's warranty. Warranty does not cover normal wear & tear.

This limited warranty is in lieu of all other warranties express or implied and BFM Seating expressly disclaims any implied warranties of merchantability or fitness for particular purpose. In no instance shall BFM Seating's liability under warranty exceed the value of the warranted item or items. Warranty as expressed does not include replacement freights or installation/removal. All warranty claims are subject to the following:

- Synthetic Teak: Excessive heat from the following sources voids warranty, prism affect of sun on footed glassware, metal objects such as condiment stands and any other object that creates excessive heat.
- Consumer properly assembling KD items
- Product is subject to normal use. Indoor furniture may not be subject to outdoor use or extremes in temperature & humidity. Outdoor furniture may not be subject to winter weather elements or excessive weather elements of any type.
- Umbrellas should not be subject to excessive wind or used in unsafe conditions in open or closed position.
- Warranty Claims must include pictures of subject product & may also require return for inspection. If returned product is deemed as abused return freight will be the responsibility of returning party.
- BFM reserves the right to determine under warranty to replace applicable part(s) or complete item.
- For any reason if any product is to be returned, a return authorization must be obtained before returning. Any product returned without a return authorization will be refused and all shipping costs will be the responsibility of the shipping party.

**We reserve the right to update or discontinue products without notice.**

**If the buyer is concerned about exact color, texture, or stain, we strongly encourage you to request a sample swatch by contacting us. Colors may vary from catalog or website images. We are not responsible for discrepancies in color, texture, or stain if a sample swatch is not requested.**

If you are an authorized dealer/vendor of BFM, BFM will add you as an additional insured under BFM's liability insurance upon request.





2080 Wheatsheaf Lane  
Philadelphia, PA 19124  
215.289.5411 **P**  
215.289.5420 **F**  
**bfmseating.com**