



THE **2024** CATALOG



design
architecture
hospitality
dining

The
AMERICAN
CAFE & LOUNGE



NP New Product

NC New Color

For Distributors Use Only

place order | orders@bfm1.com

submit a claim | returns@bfm1.com

payment information | AR@bfm1.com

need a quote | quotes@bfm1.com

need a freight quote | freightquote@bfm1.com



2080 Wheatsheaf Lane
Philadelphia, PA 19124

T: 215-289-5411 F: 215-289-5420

www.bfmseating.com



Table of Contents

Outdoor Furniture

Alpha bases	35,102
Aruba lounge seating	38,39
Avalon	14
Bali bases	34
Barnegat	17
Beachcomber tables	29
Belmar lounge seating	40,41,42
Boca bases	36
Captiva	6
Cancun booth	26
Chesapeake	16
Daytona	12
Daytona table	13,29
Elite bases	35,102
Key West	7
Kingston	15
Largo	23
Longport 4-leg tables	24,31
Longport table tops	24,32
Margate bases	34
Marina	26
Monterey	25
Seaside	18
Seaside 4-leg tables	19,30
Seaside picnic table	20
Seaside table tops	32
South Beach	8
South Beach tables	9,29
Surf Inlay tables	21,30,43
Tribeca table tops	22,32
Vista	10

Umbrellas

Aluminum market	50
Bolt-down	54
Cantilever	56
Crank lift fiberglass	46
Fiberglass market	44
G-series aluminum	52
G-series fiberglass	48
Umbrella bases	58-62
Umbrella base guide	125

Industrial Seating

Barrick	64
Dalton	65
Hamilton	67
Henry	70
Lima clear coat	71
Lincoln	69
Memphis	68
Nash	73
NV	66
The Screw barstool	72
Trent clear coat	71,84

Steel Seating

Akrin	82
Bristol	85
Dale	77
Darby	79
Espy	78
Lima	75
Lima Silver Mist	76

Meghan	80
Polk	81
Trent	84
Troy	83

Wood Seating

Aston	93
Berkeley	94
Columbia	89
Dover	92
Emma	87
Emma Cane Back	88
Giulia	91
Sofia	90
Stockton	95

Indoor Tables & Bases

Alpha base	102
Bolt-down bases	103
Cantilever & pin leg bases	103
Corner post legs	103
Elite bases	102
I-Beam bases	103
Jaxon bases	100
Midtown table tops	97
Niles bases	101
NV legs	103
Relic table tops	98
Uptown bases	100,101
Wood veneer table tops	97

Trash Receptacles

35 Gallon trash enclosures	104,105
----------------------------	---------

Server Stations

Single door server station	106,107
Double door server station	108,109

Wireless Table Charging

Key, Battery, Charging Tray, Kits	99
-----------------------------------	----

Design

Quick Ship Vinyl	110
Grade 2 vinyl	111
Grade 3 vinyl	112,113
Grade 4 vinyl and fabric	116-119
Steel seating wood seat options	110
Steel seating Relic seat options	110
Sunbrella® sofa cushion fabric	120,121
Sunbrella® patterns	122
Umbrella fabric	124

Reference

Indoor Table Base Sizing Guide	126
Outdoor Table Base Sizing Guide	127
Terms & Conditions	128
Umbrella base guide	125

Captiva series



NP

PRODUCT INFORMATION

PH401C	armchair dimensions h30.5 w16.75 sh17 sd15.5 sw16.75
PH402C	side chair dimensions h30.5 w16.75 sh17 sd15.5 sw16.75
PH402B	barstool dimensions h39.75 w18.5 sh29.25 sd14.5 sw15
weave colors	GR ● seaside gray SB ● saharah brown
frame finish	WH ● white BL ● black
materials	synthetic rope aluminum powder coat
feature	stackable (chairs only)

Key West series



PRODUCT INFORMATION

PHKWAC+finish	armchair dimensions h31 w21.25 sh17.75 sd16.5
PHKWSC+finish	side chair dimensions h31.25 w19.5 sh17.5 sd16.5
PHKWBS+finish	barstool dimensions h39.75 w20.5 sh29.25 sd15.25
frame finish	WH ○ white SG ● soft gray BL ● black BY ● berry
materials	aluminum powder coat
feature	stackable

South Beach series



PRODUCT INFORMATION

DV350TS armchair dimensions | h33.5 | w23.5 | sh18 | sd16 | sw18 | armht27

DV450TS side chair dimensions | h33.5 | w21 | sh18 | sd16 | sw18

DV550TS barstool dimensions | h39.5 | w19.75 | sh30 | sd13 | sw16

frame finish TS ● titanium silver

materials aluminum | powder coat

feature stackable

South Beach tables



PRODUCT INFORMATION

DVS+size+TS	table dimensions 24 x 32 (no umbrella hole) 32 x 32 36 x 36 32 x 48 dining height
DVS3232TSUT	table dimensions 32 x 32 bar height
frame finish	TS ● titanium silver
materials	aluminum powder coat
feature	base supports umbrella 32 x 48 weighted umbrella base required, sold separately

Vista series



PRODUCT INFORMATION

DV352+finish	armchair dimensions h33 w21.5 sh18 sd16.5 sw19.5 armht26.5
DV552+finish	barstool dimensions h40 w22.25 sh30.5 sd13.5 sw13.5
frame finish	BL ● black
materials	aluminum powder coat
feature	stackable



Daytona series



PRODUCT INFORMATION

SU2811CSG	armchair dimensions h33 w21.5 sh18 sd16 sw16 armht25.5
SU2810CSG	side chair dimensions h33 w17.75 sh18 sd16 sw16
SU2810BSG	barstool dimensions h42 w18.5 sh30 sd14.25 sw16
frame finish	SG ● soft gray BL ● black
materials	e-coated steel powder coated
feature	stackable

Daytona tables



NC

PRODUCT INFORMATION

SUD+size+U	table dimensions 24 x 32 32 x 32 32 x 48 36 x 36 dining height
SUD3232UT	table dimensions 32 x 32 bar height
frame finish	SG ● soft gray BL ● black
materials	e-coated steel powder coated
feature	ADA compliant sizes available umbrella holes weighted umbrella base required sold separately, see page 58

Avalon series



PRODUCT INFORMATION

DV354BL armchair dimensions | h34 | w22.75 | sh18 | sd17 | sw17.5 | armht26.25

DV454BL side chair dimensions | h34 | w19.5 | sh18 | sd17 | sw17.5

DV554BL barstool dimensions | h40.5 | 20.25 | sh29 | sd14 | sw16.25

frame finish BL ● black

materials e-coated steel | powder coated | steel micro mesh

feature stackable

Kingston series



PRODUCT INFORMATION

SU1601CBL armchair dimensions | h32.25 | w21.25 | sh17.5 | sd14.5 | sw17.5 | armht25.75

SU1600CBL side chair dimensions | h32.25 | w20.25 | sh17.5 | sd14.5 | sw17.75

SU1600BBL barstool dimensions | h39.75 | w19 | sh29.75 | sd13.5 | sw15.5

frame finish BL ● black

materials e-coated steel | powder coated | steel micro mesh

feature stackable

Chesapeake series



PRODUCT INFORMATION

SU1301CBL armchair dimensions | h34 | w21 | sh17.5 | sd17.5 | sw17 | armht25.5

SU1300CBL side chair dimensions | h34 | w17.75 | sh17.5 | sd17.5 | sw17

SU1300BBL barstool dimensions | h43.5 | w17.25 | sh30 | sd15.5 | sw16

frame finish BL ● black

materials e-coated steel | powder coated | steel micro mesh

features stackable

Barnegat tables

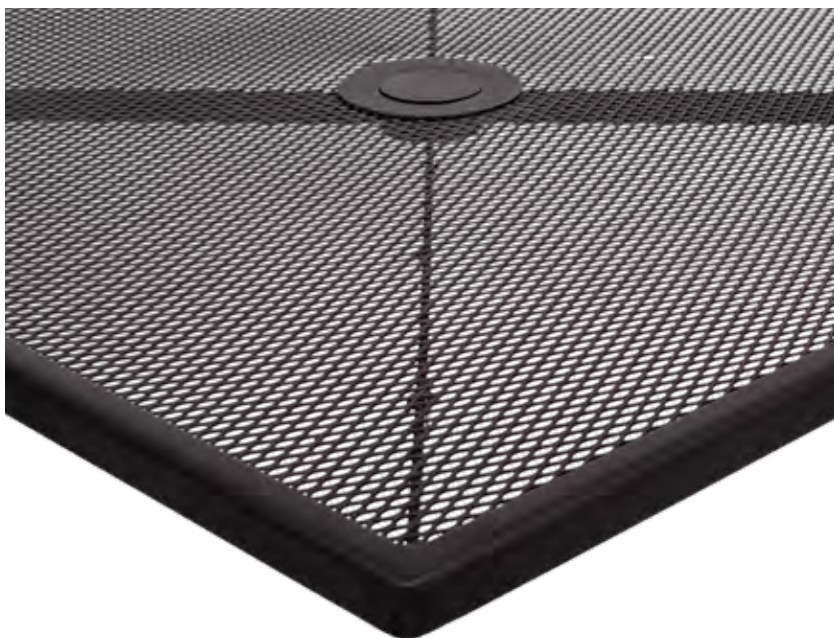

PRODUCT INFORMATION

SU+size+BL-D	table dimensions 24 x 32 30 x 30 36 x 36 24R 30R 36R 42R dining height
SU+size+BL-T	table dimensions 24 x 32 30 x 30 36 x 36 24R 30R 36R 42R bar height
frame finish	BL ● black
materials	e-coated steel powder coated steel micro mesh
feature	umbrella compatible (weighted umbrella base required, sold separately, see pg. 58 no umbrella hole 24R)

Seaside series



PRODUCT INFORMATION

PH201CGRTK+finish	armchair dimensions h33 w22 sh17.5 sd17.5 sw19.5 armht24
PH202CGRTK+ finish	side chair dimensions h33 w19 sh17.5 sd17.5 sw16
PH201BGRTK+finish	arm barstool dimensions h45 w22 sh29.5 sd17.5 sw19.5 armht36
PH202BGRTK+finish	side barstool dimensions h45 w18.75 sh29.5 sd17.5 sw15.5
frame finish	SG ● soft gray BL ● black
materials	aluminum powder coat gray synthetic teak
feature	armchair and side chair stackable

Seaside tables



PRODUCT INFORMATION

PH+size+GR+finish

table top dimensions | 24 x 30 | 30 x 30 | 34 x 34 | 30 x 51

base options

alpha | bali | margate

PH4L+size+GR+finish

4-leg table dimensions | 31 x 31 | 35 x 35 | 31 x 48 | 35 x 72 | dining height

PH4L+size+GR+finish+T

4-leg table dimensions | 31 x 48 | 35 x 72 | bar height

frame finish

SG ● soft gray | BL ● black

materials

aluminum | powder coat | gray synthetic teak

features

ADA compliant sizes available | umbrella hole not available on 24 x 30 tops or 4-leg bar height tables | margate base supports umbrella | weighted umbrella base required 4-leg and 30 x 51 tables, see page 58

Seaside series



PRODUCT INFORMATION

PH5927GR	dimensions top 27.5 d x 59 w x 29.5 h seat 12.5 d x 59 w x 18 h overall 60.25 d
PH7227GR	dimensions top 27.5 d x 72 w x 29.5 h seat 12.5 d x 72 w x 18 h overall 60.25 d
frame finish	SG ● soft gray BL ● black
materials	aluminum powder coat gray synthetic teak
features	umbrella hole optional weighted umbrella base required, sold separately, see page 58

Attention: refracting sunlight from stemware or a concentrated heat source may cause damage to synthetic surface, voiding warranty" (see page 31 for reference)

Surf Inlay tables



PRODUCT INFORMATION

PH4L+ size + finish

4-leg table dimensions | 32x32 | 36x36 | 32x48 | 36x72 | dining height

PH4L+ size + finish + T

4-leg table dimensions | 32x48 | 36x72 | bar height

inlay

CR ● carrara | ● PR pietra

frame finish

SG ● soft gray | BL ● black

materials

aluminum | powder coat | compact laminate

features

umbrella hole optional | weighted umbrella base required, sold separately, see page 58
 ADA compliant sizes available | umbrella hole not available on bar height tables

Tribeca table tops

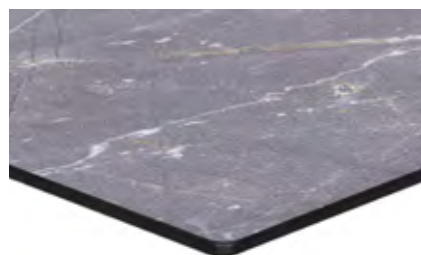
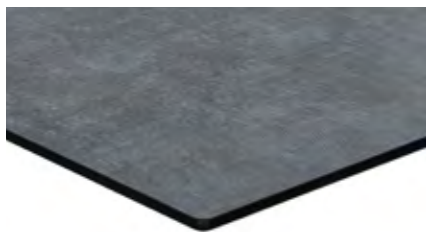

PRODUCT INFORMATION

TRN2432+finish	24 x 32	TRN32R+finish 32R
TRN3232+finish	32 x 32	TRN36R+finish 36R
TRN3248+finish	32 x 48	TRN48R+finish 48R
TRN3636+finish	36 x 36	
base options	bali margate alpha elite	
finish	FS ● frosted slate PP ● planked pine DW ● driftwood CR ● carrara ● PR pietro	
materials	compact laminate	

feature **umbrella hole options:**
 not available on 24x32
 32square, 32round, 36square, 36round, and 48round requires margate base
 32x48 requires bali end bases and weighted umbrella base, sold separately, see page 58

Largo series



PRODUCT INFORMATION

PH101CTK+finish	armchair dimensions h33 w22 sh17.25 sd18 sw19 armht24
PH102CTK+finish	side chair dimensions h33 w18.5 sh17.5 sd17 sw16.5
PH101BTK+finish	arm barstool dimensions h45.75 w22 sh29.25 sd18 sw19 armht36
PH102BTK+finish	side barstool dimensions h45.5 w18.5 sh29.75 sd17.5 sw16.5
frame finish	BL ● black SV ● silver
materials	aluminum powder coat synthetic teak
feature	armchair and side chair stackable

Longport tables



PRODUCT INFORMATION

PH+size+TK+finish	table top dimensions 24 x 24 24 x 30 32 x 32 35 x 35 32 x 48 24R 32R 34R
base options	alpha bali margate
PH4L+size+TK+finish	4-leg table dimensions 32 x 32 35 x 35 32 x 48 35 x 71 dining height
PH4L+size+TK+finish+T	4-leg table dimensions 32 x 48 35 x 71 bar height
frame finish	BL ● black SV ● silver
materials	aluminum powder coat synthetic teak table top
features	ADA compliant sizes available umbrella hole not available on 24x24, 24x30 tops or 4-leg bar height tables margate base supports umbrella weighted umbrella base required 4-leg and 32x48 tables, see page 58

Attention: refracting sunlight from stemware or a concentrated heat source may cause damage to synthetic surface, voiding warranty.

Monterey series



PRODUCT INFORMATION

PH501CJV armchair dimensions | h34.5 | w21.75 | sh18 | sd17 | sw 18 | armht24

PH500CJV side chair dimensions | h34 | w19 | sh18 | sd17 | sw 16

PH500BJV barstool dimensions | h42.25 | w18.75 | sh29.75 | sd16 | sw 18.5

wicker color JV ● java

materials aluminum | outdoor synthetic weave

features stackable side and armchair | aluminum leg endcaps

Cancun booth



Marina series



PRODUCT INFORMATION

PH7100JV	Cancun booth bench dimensions h37.5 w48 sh17.5 sd18
wicker color	JV ● java
materials	aluminum frame powder coat outdoor synthetic weave
features	2" cushion available aluminum foot caps
PH11CBBBL	Marina armchair dimensions h30 w21 sh17.75 sd18 sw19.5 armht27
PH10BBBBL	Marina backless barstool dimensions h30.75 w17.25 sd13.25 sw13.25
frame finish	black powder coat brown/black weave & binding
materials	aluminum frame powder coat outdoor synthetic weave 2" cushion available, sold separately
feature	armchair stackable



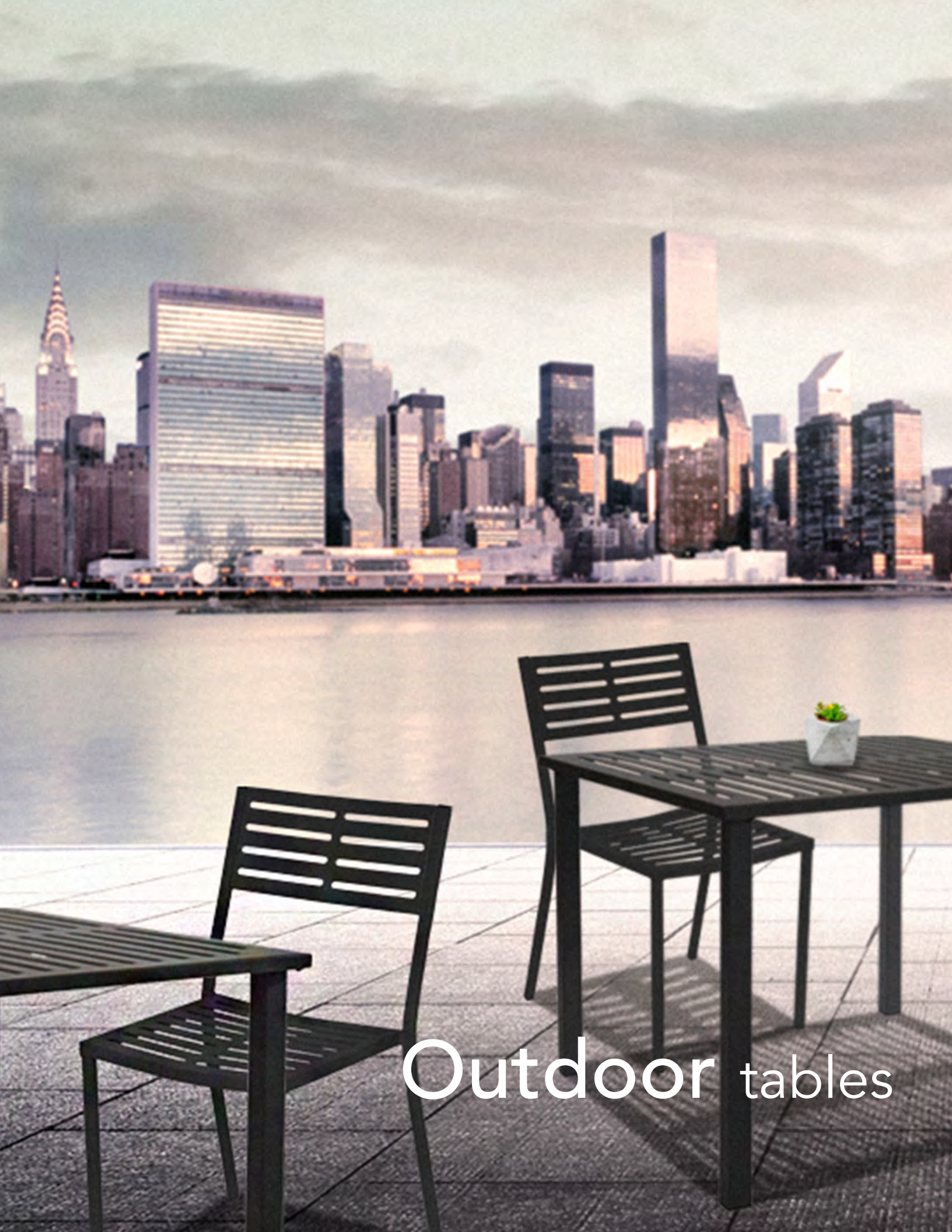

Outdoor tables

South Beach tables



DVS2432TS | dining height table | 24 x 32 (umbrella hole N/A)

DVS3232TSU | dining height table | 32 x 32

DVS3636TSU | dining height table | 36 x 36

DVS3248TSU | dining height table | 32 x 48

DVS3232TSUT | bar height table | 32 x 32

finish | TS ● titanium silver powder coat

materials | powder coated aluminum

features | base supports umbrella | base included | 32x48 table requires weighted umbrella base, sold separately, see page 58

Daytona tables



SUD2432U | 4-leg dining height table | 24 x 32

SUD3232U | 4-leg dining height table | 32 x 32

SUD3248U | 4-leg dining height table | 32 x 48

SUD3636U | 4-leg dining height table | 36 x 36

SUD3232UT | 4-leg bar height table | 32 x 32

finish | SG ● soft gray | BL ● black

materials | aluminum | powder coat

feature | corner leg design | umbrella capability | weighted umbrella base required, sold separately, see page 58
ADA compliant sizes available

Beachcomber tables



PHB2432 | dining height table | 24 x 32

PHB3232 | dining height table | 32 x 32

PHB3248 | dining height table | 32 x 48

PHB3636 | dining height table | 36 x 36

PHB2432T | bar height table | 24 x 32

PHB3232T | bar height table | 32 x 32

PHB3636T | bar height table | 36 x 36

PHB3048T | bar height table | 30 x 48

finish | WH ○ white | BL ● black | BY ● berry

materials | powder coated aluminum

base option | margate or bali | margate supports umbrella

30x48 tables require weighted umbrella base, sold separately see page 58

Surf Inlay tables



PH4L3232TK | 4-leg bolt-down table | 32 x 32

PH4L3248TK | 4-leg bolt-down table | 32 x 48 (ADA compliant)

PH4L36365TK | 4-leg bolt-down table | 36 x 36

PH4L3672TK | 4-leg bolt-down table | 36 x 72 (ADA compliant)

PH4L3248TKT | 4-leg bolt-down table bar height | 32 x 48

PH4L3671TKT | 4-leg bolt-down table bar height | 36 x 71

inlay | CR ● carrara | ● PR pietro

frame finish | SG ● soft gray | BL ● black

materials | aluminum | powder coat | compact laminate

umbrella hole optional | weighted umbrella base required, sold separately, see page 58 | ADA compliant sizes available
 umbrella hole not available on bar height tables | bolt-down feature

Seaside tables



PH4L3131GR | 4-leg bolt-down table | 31 x 31

PH4L3148GR | 4-leg bolt-down table | 31 x 48 (ADA compliant)

PH4L3535GR | 4-leg bolt-down table | 35 x 35

PH4L3572GR | 4-leg bolt-down table | 35 x 72 (ADA compliant)

PH4L3148GRT | 4-leg bar height bolt-down table | 31 x 48

PH4L3572GRT | 4-leg bar height bolt-down table | 35 x 72

finish | synthetic teak | frame options BL ● black | SG ● soft gray

materials | synthetic wood | aluminum | powder coat

feature | corner leg design | umbrella hole optional (dining height only) | weighted umbrella base required, sold separately, see page 58 | ADA compliant sizes available
 bolt-down feature

Longport tables



PH4L3232TK | 4-leg bolt-down table | 32 x 32

PH4L3248TK | 4-leg bolt-down table | 32 x 48 (ADA compliant)

PH4L3535TK | 4-leg bolt-down table | 35 x 35

PH4L3571TK | 4-leg bolt-down table | 35 x 71 (ADA compliant)

PH4L3248TKT | 4-leg bolt-down table bar height | 32 x 48

PH4L3571TKT | 4-leg bolt-down table bar height | 35 x 71

finish | synthetic teak | frame options BL ● black | SV ● silver

materials | synthetic wood | aluminum | powder coat

feature | corner leg design | umbrella hole optional (dining height only)
| weighted umbrella base required, sold separately, see page 58 | ADA compliant sizes available
bolt-down feature

Seaside table tops



PH2430GRTK | 24 x 30
 PH3030GRTK | 30 x 30
 PH3434GRTK | 34 x 34
 PH3051GRTK | 30 x 51

finish | SG ● soft gray edge | ● BL black edge

materials | gray synthetic teak | aluminum sub-frame
 powder coat

base option | margate or bali or alpha | margate supports
 umbrella | 30 x 51 requires weighted umbrella
 base, sold separately, see page 58

feature | umbrella hole upon request (margate only)

Longport table tops



PH2424TK | 24 x 24 PH3248TK | 32 x 48
 PH2432TK | 24 x 32 PH24RTK | 24R
 PH3232TK | 32 x 32 PH32RTK | 32R
 PH3636TK | 35 x 35 PH36RTK | 34R

finish | SV ● silver edge | BL ● black edge

materials | synthetic teak | aluminum sub-frame | powder coat

base option | margate or bali or alpha | margate supports um-
 brella | 32x48 requires a weighted umbrella base,
 sold separately, see page 58

feature | umbrella hole upon request (margate only) except 24x24 & 24R

Tribeca table tops

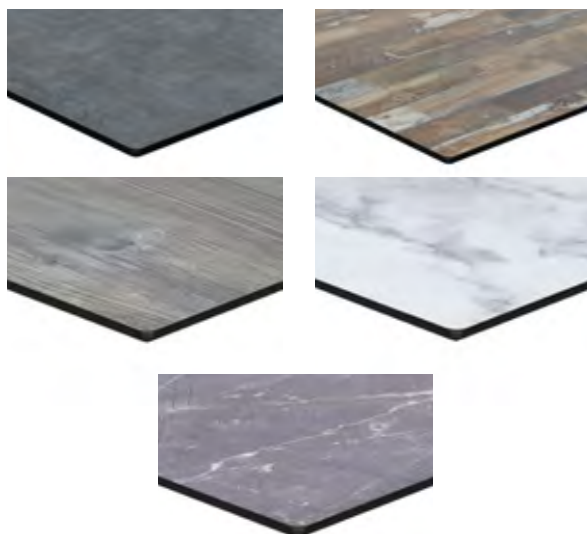

TRN2432+finish | 24 x 32 TRN32R+finish | 32R
 TRN3232+finish | 32 x 32 TRN36R+finish | 36R
 TRN3248+finish | 32 x 48 TRN48R+finish | 48R
 TRN3636+finish | 36 x 36

finish | FS ● frosted slate | PP ● planked pine | DW ● driftwood
 CR ● carrara | PR ● pietro

materials | compact laminate

feature | umbrella hole optional (margate bases only)
 32x48 requires a weighted umbrella base, sold separately, see page 58



Outdoor bases



Margate

PHBT+size+SQ | square dining height

PHBT+size+SQT | square bar height

base dimension | 16 x 16 | 18 x 18 | 20 x 20
24 x 24

finish | BL ● black | SV ● silver
Additional 18sq & 20sq base finishes
WH ○ white | BY ● berry

materials | powder coated | zinc plated cast iron
stainless steel column

features | center post base with umbrella
capabilities, pinch nut



Margate

PHTB+size+R | round dining height

PHTB+size+RT | round bar height

base dimension | 16 | 18 | 20 | 24

finish | BL ● black | SV ● silver

materials | powder coated | zinc plated cast
iron, stainless steel column

features | center post base with umbrella
capabilities, pinch nut



Bali

PHTB2626 | cross base dining height

PHTB2626T | cross base bar height

base dimension | 26 x 26

finish | BL ● black | SV ● silver
WH ○ white | BY ● berry

materials | powder coated cast
aluminum

feature | additional cast weight



Bali end

PHTB0022 | dining height (sold as pair)

PHTB0022T | bar height (sold as pair)

base dimension | 22 x 3.25

finish | BL ● black | SV ● silver
WH ○ white | BY ● berry

materials | powder coated | weighted cast
aluminum

feature | compatible with Margate series



Bali folding

PHTB2626F | folding dining height

base dimension | 26 x 26

finish | BL ● black | SV ● silver

materials | powder coated, weighted
cast aluminum

feature | folding

capabilities | safely holds up to 32" top

Outdoor bases



Elite square

PHTB+size+SQSS | dining height

PHTB+size+SQSST | bar height

base dimension | 18 x 18 | 24 x 24

materials | 304 brushed stainless steel



Elite round

PHTB+size+RSS | dining height

PHTB+size+RSST | bar height

base dimension | 18 | 24

materials | 304 brushed stainless steel



Elite end

PHTB0024SS | dining height (sold as pair)

PHTB0024SST | end bases bar height (sold as pair)

base dimension | 4 x 24

materials | 304 brushed stainless steel

feature | ADA capabilities



Elite double column

PHTB1630SS | dining height

PHTB1630SST | bar height

base dimension | 16 x 30

materials | 304 brushed stainless steel



Alpha

PHTB-BDSS | bolt-down base dining height

PHTB-BDSST | bolt-down base bar height

base dimension | 8

finish | SS ● stainless steel

materials | 304 brushed stainless steel powder coated

capabilities | bolt down



Alpha

PHTB-BD

PHTB-BDT | bolt-down base bar height

base dimension | 8

finish | BL ● black | SV ● silver

materials | 304 stainless steel

capabilities | bolt down

print or web page colors and overall dimensions are for reference only

Outdoor bases



Boca

PHTB501 | 4-leg dining height

base spread | 24"

finish | BL ● black

materials | powder coated cast aluminum



Boca bar height

PHTB503 | 4-leg bar height

base spread | 24"

finish | BL ● black

materials | powder coated cast aluminum



Boca umbrella

PHTB502 | umbrella base standard height

base spread | 33"

finish | BL ● black

materials | powder coated cast aluminum

feature | umbrella compatible
(weighted umbrella base required, sold separately, see page 58)



Boca trestle

PHTB504 | trestle base standard height

base spread | 24" x 36.5"

supports | 32 x 48

finish | BL ● black

materials | powder coated cast aluminum



Modular seating

Aruba series



PH5101JV-L/R | left or right arm sofa

dimensions | h26 | w29 | d29

finish | java

materials | aluminum | synthetic wicker

features | 4" seat cushion with wedge design back | cushion D-hooks | sectional connection hooks | L sectional capability

cushion | sold separately | 73 colors available
upholstery found on pages 120–122



PH5101JV-MW | large middle sofa

dimensions | h26 | w25.25 | d29

finish | java

materials | aluminum | synthetic wicker

features | 4" seat cushion with wedge design back | cushion D-hooks | sectional connection hooks | L sectional capability

cushion | sold separately | 73 colors available
upholstery found on pages 120–122



PH5101JV-C | corner sofa

dimensions | h26 | w29 | d29

finish | java

materials | aluminum | synthetic wicker

features | 4" seat cushion with wedge design back | cushion D-hooks | sectional connection hooks | L sectional capability

cushion | sold separately | 73 colors available
upholstery found on pages 120–122



PH5102JV | armchair

dimensions | h26 | w29 | d29

finish | java

materials | aluminum | synthetic wicker

features | 4" seat cushion with wedge design back | cushion D-hooks

cushion | sold separately | 73 colors available
upholstery found on pages 120–122



PH5106JV | ottoman

dimensions | h14 | w25 | d25

finish | java

materials | aluminum | synthetic wicker

features | 4" seat cushion

cushion | sold separately | 73 colors available
upholstery found on pages 120–122



PH5104JV | coffee table

dimensions | h14 | w30 | d30

finish | java

materials | aluminum | synthetic wicker

feature | tempered glass sold separately



PH5105JV | end table

dimensions | h16 | w18 | d18

java

materials | aluminum, synthetic wicker

feature | tempered glass sold separately

Belmar series



PH6101-L | left arm facing sectional

dimensions | h25.75 | w28.25 | d28.25

finish | SG ● soft gray | BL ● black

materials | aluminum powder coat

features | 6" seat cushion with wedge design back | cushion D-hooks | sectional connection hooks | L sectional capability

cushion | sold separately | 73 colors available
upholstery found on pages 120-122



PH6101-R | right arm facing sectional

dimensions | h25.75 | w28.25 | d28.25

finish | SG ● soft gray | BL ● black

materials | aluminum powder coat

features | 6" seat cushion with wedge design back | cushion D-hooks | sectional connection hooks | L sectional capability

cushion | sold separately | 73 colors available
upholstery found on pages 120-122



PH6101-M | armless middle sofa

dimensions | h25.75 | w25.5 | d28.25

finish | SG ● soft gray | BL ● black

materials | aluminum powder coat

features | 6" seat cushion with wedge design back | cushion D-hooks | sectional connection hooks | L sectional capability

cushion | sold separately | 73 colors available
upholstery found on pages 120–122



PH6102 | armchair

dimensions | h25.75 | w28.25 | d28.25

finish | SG ● soft gray | BL ● black

materials | aluminum powder coat

features | 6" seat cushion with wedge design back | cushion D-hooks

cushion | sold separately | 73 colors available
upholstery found on pages 120–122

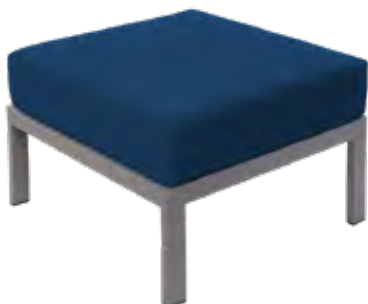

PH6106 | ottoman

dimensions | h12 | w27.5 | d25.5

finish | SG ● soft gray | BL ● black

materials | aluminum powder coat

features | 6" seat cushion

cushion | sold separately | 73 colors available
upholstery found on pages 120–122

Belmar series



PH6104 | coffee table

dimensions | h16 | w47 | d23.5

finish | SG ● soft gray | BL ● black

materials | aluminum powder coat

feature | large 2" legs with slat design surface



PH6105 | end table

dimensions | h16 | w21.5 | d21.5

finish | SG ● soft gray | BL ● black

materials | aluminum powder coat

feature | large 2" legs with slat design surface

Inlay series



SURF INLAY

PH4L + size + table color + frame finish | dining table

dimensions | 36x36 | 32x48 | 32x48 bar height
36x72 | 36x72 bar height

finish | SG ● soft gray | BL ● black

table top | CR ● carrara | ● PR pietro

materials | aluminum powder coat | compact laminate

umbrella hole optional | weighted umbrella base required, sold separately, see page 58 | ADA compliant sizes available
umbrella hole not available on bar height tables



BELMAR INLAY

PH6104 + inlay color + finish color | coffee table

dimensions | h16 | w47 | d23.5

finish | SG ● soft gray | BL ● black

inlay | CR ● carrara | ● PR pietro

materials | aluminum powder coat | compact laminate

feature | large 2" legs



BELMAR INLAY

PH6105 + inlay color + finish color | end table

dimensions | h16 | w21.5 | d21.5

finish | SG ● soft gray | BL ● black

inlay | CR ● carrara | ● PR pietro

materials | aluminum powder coat | compact laminate

feature | large 2" legs

Fiberglass Market umbrellas



PULLEY LIFT

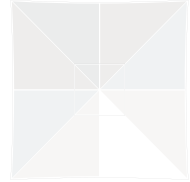
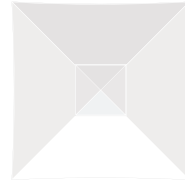
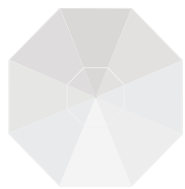

AVAILABLE FRAME SIZES

U7.5F: 7.5' OCTAGON	U9F: 9' OCTAGON	U11F: 11' OCTAGON	U6.5F: 6.5' SQUARE	U7.5SQF: 7.5' SQUARE
A: height: 94"	A: height: 97"	A: height: 107"	A: height: 97"	A: height: 107"
B: clearance: 76"	B: clearance: 77"	B: clearance: 82"	B: clearance: 77"	B: clearance: 82"
C: upper pole 66"	C: upper pole 69"	C: upper pole 77"	C: upper pole 69"	C: upper pole 77"
D: lower pole: 37"	D: lower pole: 37"	D: lower pole: 37"	D: lower pole: 37"	D: lower pole: 37"
mast diameter: 1.5"	mast diameter: 1.5"	mast diameter: 1.5"	mast diameter: 1.5"	mast diameter: 1.5"
weight: 16 lbs.	weight: 20 lbs.	weight: 22 lbs.	weight: 15 lbs.	weight: 18 lbs.
frame finish SV silver SM silver mist WG wood grain BL black BZ bronze WH white HW Heather Willow CB Carbon				
fabric color options on page 124				



COMMERCIAL PULLEY SYSTEM



HIGH IMPACT POLYMER JOINTS AND
.5" FIBERGLASS RIBS

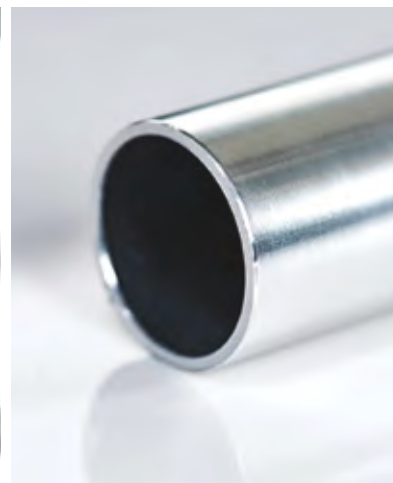

1.5" DIAMETER CENTER POLE

HIGH IMPACT TPU COPOLYMER FINIALS



Standard: CLASSIC BALL FINIAL
Finial will match selected frame finish



Optional: VERTEX FINIAL
Finial will match selected frame finish

FINISHES AVAILABLE



FEATURES

- Smooth and effortless pulley system.
- 1/2" fiberglass ribs and struts for maximum strength and flexibility.
- 1.5" diameter center pole with a 1/8" aluminum wall thickness provides incredible strength and durability.
- Stainless steel grommets attach the canopy securely to the frame.
- Modular design.
- Stainless steel hardware throughout.

BASE OPTIONS

- UB100RSM aluminum shell (page 58) | UB70RD resin coated concrete (page 58) | UB50RD resin coated concrete (page 58)
- UB75SQ steel plate (page 58) | UBBD camlock (page 62) | UBG24RSM galvanized steel (page 59) | UBG30RSM galvanized steel (page 59)

Crank Lift Fiberglass umbrellas



COMMERCIAL CRANK LIFT - NO TILT

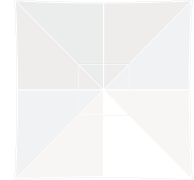
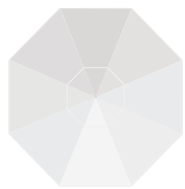

AVAILABLE FRAME SIZES

U7.FC: 7.5' OCTAGON	U9FC: 9' OCTAGON	U11FC: 11' OCTAGON	U6.5FC: 6.5' SQUARE	U7.5SQFC: 7.5' SQUARE
A: height: 98"	A: height: 107"	A: height: 108"	A: height: 107"	A: height: 108"
B: clearance: 72"	B: clearance: 79"	B: clearance: 87"	B: clearance: 79"	B: clearance: 87"
C: upper pole 66"	C: upper pole 69"	C: upper pole 77"	C: upper pole 69"	C: upper pole 77"
D: lower pole: 37"	D: lower pole: 37"	D: lower pole: 37"	D: lower pole: 37"	D: lower pole: 37"
mast diameter: 1.5"	mast diameter: 1.5"	mast diameter: 1.5"	mast diameter: 1.5"	mast diameter: 1.5"
weight: 17 lbs.	weight: 22 lbs.	weight: 24 lbs.	weight: 18 lbs.	weight: 21 lbs.
frame finish SV silver SM silver mist WG wood grain BL black BZ bronze WH white HW Heather Willow CB Carbon				
fabric color options on page 124				



COMMERCIAL CRANK SYSTEM



HIGH IMPACT POLYMER JOINTS AND .5" FIBERGLASS RIBS



1.5" DIAMETER CENTER POLE

HIGH IMPACT TPU COPOLYMER FINIALS



Standard: CLASSIC BALL FINIAL

Finial will match selected frame finish.



Optional: VERTEX FINIAL

Finial will match selected frame finish.

FINISHES AVAILABLE



FEATURES

- 316 cast solid stainless steel crank handle and axle.
- 1/2" fiberglass ribs and struts for maximum strength and flexibility.
- 1.5" diameter center pole with a 1/8" aluminum wall thickness provides incredible strength and durability.
- Stainless steel grommets attach the canopy securely to the frame.
- Modular design.
- Stainless steel hardware throughout.

BASE OPTIONS

- UB100RSM aluminum shell (page 58) | UB70RD resin coated concrete (page 58) | UB50RD resin coated concrete (page 58)
- UB75SQ steel plate (page 58) | UBBD camlock (page 62) | UBG24RSM galvanized steel (page 59) | UBG30RSM galvanized steel (page 59)

G-Series Fiberglass Market umbrellas

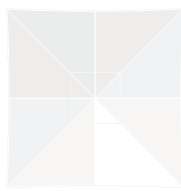
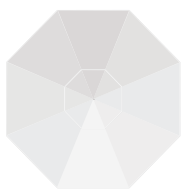

AVAILABLE FRAME SIZES

U13F: 13' OCTAGON

U10F 10' SQUARE

U8511F: 8.5' x11' RECTANGLE

A: height: 115"	A: height: 115"	A: height: 115"
B: clearance: 85"	B: clearance: 87"	B: clearance: 86"
closed clearance: 30"	closed clearance: 25"	closed clearance: 28"
mast diameter: 2"	mast diameter: 2"	mast diameter: 2"
weight: 38 lbs.	weight 36 lbs.	weight 33 lbs.

standard frame finish

● SV silver

fabric color options on page 124



POLISHED SILVER ANODIZED ALUMINUM FINISH



HIGH IMPACT POLYMER JOINTS AND .75" FIBERGLASS RIBS



COMMERCIAL DOUBLE PULLEY SYSTEM

MARINE GRADE CHROME PLATED ALUMINUM FINIALS



Standard: CLASSIC BALL FINIAL



Optional: VERTEX FINIAL

FEATURES

Smooth and effortless double pulley system.

.75" diameter fiberglass ribs and struts support this giant canopy, and provides strength and rigidity.

2" diameter single piece aluminum center pole is 3 mm thick, provides incredible strength and durability.

Modular design.

Stainless steel hardware throughout.

Multiple mounting options are available, either semi-permanent or base mounted.

BASE OPTIONS

UBG36RSM galvanized steel (page 59) | UBG40RSM galvanized steel (page 60) | UB480 heavy duty wheel (page 60)

UB150RSM aluminum shell (page 59)

Aluminum Market umbrellas

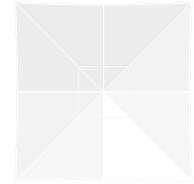
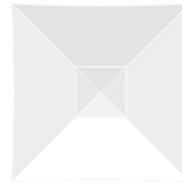
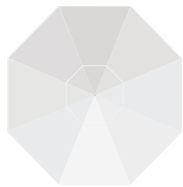

AVAILABLE FRAME SIZES

U7.5ASV: 7.5' OCTAGON	U9ASV: 9' OCTAGON	U11ASV: 11' OCTAGON	U6.5ASV: 6.5' SQUARE	U7.5SQASV: 7.5' SQUARE
A: height: 94"	A: height: 102"	A: height: 108"	A: height: 102"	A: height: 108"
B: clearance: 70"	B: clearance: 76"	B: clearance: 82"	B: clearance: 76"	B: clearance: 82"
C: upper pole 63"	C: upper pole 69"	C: upper pole 77"	C: upper pole 69"	C: upper pole 77"
D: lower pole: 37"	D: lower pole: 37"	D: lower pole: 37"	D: lower pole: 37"	D: lower pole: 37"
mast diameter: 1.5"	mast diameter: 1.5"	mast diameter: 1.5"	mast diameter: 1.5"	mast diameter: 1.5"
weight: 17 lbs.	weight: 22 lbs.	weight: 24 lbs.	weight: 15 lbs.	weight: 21 lbs.
standard frame finish	SV  silver			
fabric color options on page 124				



POLISHED SILVER ANODIZED ALUMINUM FINISH



HIGH IMPACT POLYMER JOINTS AND EXTRUDED ALUMINUM RIBS



COMMERCIAL PULLEY SYSTEM

MARINE GRADE CHROME PLATED ALUMINUM FINIALS



Standard: VERTEX FINIAL



Optional: CLASSIC BALL FINIAL

FEATURES

Smooth and effortless pulley system.

Ergonomically designed ribs maintain the shape and provide added strength.

1.5" diameter, 1/8" wall thickness aluminum center pole provides incredible strength and durability.

Stainless steel hardware throughout.

Multiple mounting options are available, either semi-permanent or base mounted.

BASE OPTIONS

UB100RSM aluminum shell (page 58) | UB70RD resin coated concrete (page 58) | UB50RD resin coated concrete (page 58)

UB75SQ steel plate (page 58) | UBBD camlock (page 62) | UBG24RSM galvanized steel (page 59) | UBG30RSM galvanized steel (page 59)

G-Series Aluminum Market umbrellas

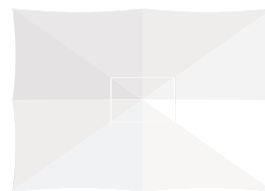
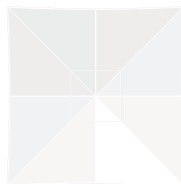
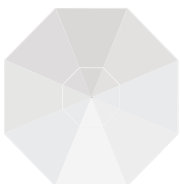

AVAILABLE FRAME SIZES

U13ASV: 13' OCTAGON

U10ASV: 10' SQUARE

U10ASV: 10' RECTANGLE

A: height: 115"

A: height: 115"

A: height: 115"

B: clearance: 85"

B: clearance: 87"

B: clearance: 86"

closed clearance: 20"

closed clearance: 23"

closed clearance: 23"

mast diameter: 2"

mast diameter: 2"

mast diameter: 2"

weight: 38 lbs.

weight 36 lbs.

weight 33 lbs.

standard frame finish

SV  silver

fabric color options on page 124



POLISHED SILVER ANODIZED ALUMINUM FINISH



HIGH IMPACT POLYMER JOINTS AND EXTRUDED ALUMINUM RIBS



COMMERCIAL DOUBLE PULLEY SYSTEM

MARINE GRADE CHROME PLATED ALUMINUM FINIALS



Standard: VERTEX FINIAL



Optional: CLASSIC BALL FINIAL

FEATURES

Smooth and effortless double pulley system.

Ergonomically designed ribs maintain the shape and provide added strength.

2" diameter single piece aluminum center pole is 3 mm thick, provides incredible strength and durability.

Stainless steel hardware throughout.

Multiple mounting options are available, either semi-permanent or base mounted.

BASE OPTIONS

UBG36RSM galvanized steel (page 59) | UBG40RSM galvanized steel (page 60) | UB480 heavy duty wheel (page 60)

UB150RSM aluminum shell (page 59)

Bolt-Down umbrellas

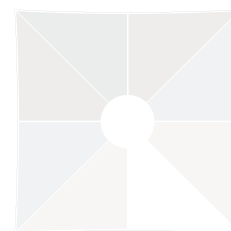

AVAILABLE FRAME SIZES

UBD16R: 16' OCTAGON

UBD13SQ: 13' SQUARE

A: open height: 126"

A: open height: 126"

B: closed height: 168"

B: closed height: 168"

C: clearance: 98"

C: clearance: 96"

D: crank clearance: 43"

D: closed clearance: 52"

E: mast diameter: 4"

mast diameter: 4"

weight: 260 lbs.

E: weight: 220 lbs.

standard frame finish

SM  silver mist

fabric color options on page 124



TELESCOPING MAST



DOUBLE REINFORCED JOINTS



EXTRUDED ALUMINUM MAST

FEATURES

As the telescoping cranks down, the top portion of the mast rises, allowing you to completely close the umbrella without having to move any furniture placed underneath.

4" diameter aluminum center pole with four internal strength channels, combined with the extruded aluminum ribs provide exceptional support and strength.

For easier installation of an umbrella this large, the mounts to a hinged spigot. This allows for the umbrella mast to be placed onto the spigot while the unit is on its side, prior to raising it to an upright position.

Reinforced grommets paired with an ultra-durable woven nylon wrap prevent the chance of fabric tearing from the frame.

Engineered to withstand 50-60 MPH sustained winds.

Stainless steel hardware throughout.

Please consult a licensed professional for in-ground or surface mounting installations.

BASE OPTIONS

UB550 heavy duty (page 61) | UBINGF (page 62) in-ground mount | UB20DP direct surface (page 61)

Cantilever umbrellas

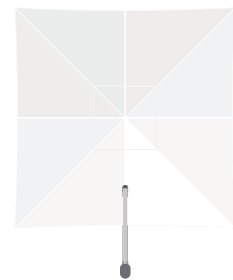
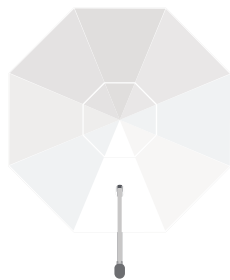

AVAILABLE FRAME SIZES

UC13R: 13' OCTAGON

UC10SQ: 10' SQUARE

A: height: 110"

A: height: 112"

B: clearance: 82"

B: clearance: 82"

C: open depth: 163"

C: open depth: 135"

closed clearance: 30"

closed clearance: 27"

mast diameter: 3.3" x 5"

mast diameter: 3.3" x 5"

weight: 140 lbs.

weight: 120 lbs.

frame finish

SM  silver mist

fabric color options on page 124

special feature: wind stabilizer bars and black polyester protective cover included.



INFINITY TILT

EXTRUDED ALUMINUM ON ALL
CRITICAL JOINTS

EXTRUDED ALUMINUM MAST

FEATURES

Full 360° rotation, combined with the Infinity Tilt system, allows for countless tilt angles, providing hours of maximum shade regardless of the position of the sun.

The crank lift is built for commercial use, yet designed for smooth and effortless operation in any environment.

The mast and all critical joints are extruded aluminum, ensuring unmatched strength and durability.

Engineered to withstand 35 MPH winds. Included wind stabilizer kit increases by 5 MPH.

Stainless steel hardware throughout.

Please consult a licensed professional for in-ground or surface mounting installations.

BASE OPTIONS

UBG40R555 galvanized steel (page 60) | UB550 heavy duty (page 61) | UB12DP direct surface (page 61)

UBINGF in-ground mount (page 62)

Umbrella bases



UB50RD | resin coated concrete base for use with umbrella tables

weight | 50 lbs.

diameter | 16"

height | 7"

stem heights | n/a

stem diameter | 1.5"

finish | SM ● silver mist | BL ● black | BZ ● bronze | WH ● white



UB75SQ | steel plate base for stand alone umbrellas

weight | 75 lbs.

dimension | 24 x 24"

height | .5"

stem height | 16"

stem diameter | 1.5"

finish | SM ● silver mist | BL ● black | BZ ● bronze | WH ● white

features | wheels for easy transport, can be secured directly to surface
not guaranteed in salt air



UB70RD | resin coated concrete base for use with umbrella tables

weight | 70 lbs.

diameter | 20"

height | 3.5"

stem height | 8"

stem diameter | 1.5"

finish | WH ● white | SM ● silver mist | BL ● black | BZ ● bronze

features | resin coated, concrete filled. 2 piece base, secondary weight ring fits onto base



UB100RSM | aluminum shell base

weight | 100 lbs.

diameter | 24"

height | 4"

stem heights | 8" for tables | 18" for stand alone umbrellas

stem diameter | 1.5"

finish | SM ● silver mist

features | concrete filled, wheels



UB150RSM | aluminum shell base

weight | 150 lbs.

diameter | 30"

height | 4"

stem height | 18" for stand alone umbrellas

stem diameters | 1.5" / 2"

finish | SM ● silver mist

features | concrete filled, wheels



UBG24RSM | galvanized steel plate base

weight | 70 lbs.

diameter | 24"

base height | .5"

stem height | 8" for tables

stem diameters | 1.5"

finish | SM ● silver mist

feature | can stack up to 3 of any G-Plates for increased weight and footprint



UBG30RSM | galvanized steel plate base

weight | 100 lbs.

diameter | 30"

base height | .5"

stem height | 18" for stand alone umbrellas

stem diameters | 1.5"

finish | SM ● silver mist

feature | can stack up to 3 of any G-Plates for increased weight and footprint



UBG36RSM | galvanized steel plate base

weight | 150 lbs.

diameter | 36"

base height | .5"

stem height | 18" for stand alone umbrellas

stem diameters | 1.5" / 2"

finish | SM ● silver mist

feature | can stack up to 3 of any G-Plates for increased weight and footprint

Umbrella bases



UBG40RSM | galvanized steel plate base

weight | 185 lbs.

diameter | 40"

base height | .5"

stem heights | 18" for stand alone umbrellas

stem diameters | 1.5" / 2"

finish | SM ● silver mist

feature | can stack up to 3 of any G-Plates for increased weight and footprint



UBG40R555 | galvanized steel plate stack

weight | 555 lbs.

diameter | 40"

base height | 2"

finish | SM ● silver mist

features | triple 40G stack is a required base option for the Cantilever,
all 3 plates bolt together, spigot mounts to top plate



UB480 | heavy duty wheel base (minimum weight required 480 lbs and ships empty, pavers not included)

weight | 80 lbs.

dimension | 33 x 34"

height | 10.5" with wheels | 6.5" w/o wheels

finish | SM ● silver mist

features | Holds three 16" pavers per quadrant (12 total pavers).
Minimum paver weight per quadrant must be 105 lbs.
(35 lbs. per paver) | for 2" diameter pole G-series umbrellas



UB550 | heavy duty base

weight | 550 lbs.

dimension | 45 x 45"

height | 5"

finish | SM ● silver mist

features | galvanized steel frame, smooth aluminum lid housing pavers, bolt-down or cantilever spigot mounts directly to universal deck plate on lid



UB12DP | direct surface mounting plate for cantilever

weight | 12 lbs.

diameter | 12"

height | 5"

finish | BL ● black

features | direct surface mounting deck plate, can be mounted to concrete or wood deck or any stable solid surface



UB20DP | direct surface mounting plate for bolt-down

weight | 20 lbs.

diameter | 20"

height | .5"

finish | SM ● silver mist

features | direct surface mounting deck plate, can be mounted to concrete, wood deck, or any stable solid surface

Umbrella bases



UBBD | camlock surface mount

weight | 9 lbs.

stem height | 18"

plate diameter | 4"

stem diameter | 1.5"

finish | SM ● silver mist

features | Direct surface mounting plate. Concrete or wood deck or any stable solid surface. Stem can be removed for storage. (HARDWARE NOT INCLUDED)



UBINGF | in-ground mount for bolt-down & cantilever

weight | 18 lbs.

diameter | 8"

height | 20"

finish | SM ● silver mist

features | in-ground mounting in soil, clay or concrete



Industrial seating

Barrick series



NP

PRODUCT INFORMATION

2165C+seat+SM side chair dimensions | h32.5 | w17 | sh17.5 | sd16.5

2165B+seat+SM barstool dimensions | h42.5 | w17 | sh29 | sd16.5

frame finish sand black power coat | clear coat

standard vinyl colors BLV ● black

wood seat and back colors ASH ● autumn ash

materials welded 18 gauge steel

features upgraded vinyl and textile upholstery options found on pages 111 - 119 | C.O.M.

Dalton series



PRODUCT INFORMATION

JS66CASH-AACL	side chair dimensions h34 w21.75 sh17 sd15.25 sw15
JS66BASH-AACL	barstool dimensions h41.75 w22 sh29.25 sd16 sw15
frame finish	CL ● clear coat
wood finish	AA ● autumn ash veneer
materials	welded tubular steel clear powder coat finish veneer seat and back seat includes metal accent slats
feature	stackable (side chair only)

NV series



PRODUCT INFORMATION

JS44CASH-AASB	side chair dimensions h33.5 w19.25 sh19 sd17
JS44HASH-AASB	counter stool dimensions h40 w19.25 sh26 sd17
JS44BASH-AASB	barstool dimensions h43.5 w19.25 sh29.5 sd17
frame finish	SB ● sand black
wood finish	AA ● autumn ash
materials	solid steel rod ash veneer wood
seat options	wood upholstered
feature	upholstery found on pages 111 - 119 C.O.M.

Hamilton series



PRODUCT INFORMATION

JS10CNTV-NTPL side chair dimensions | h32 | w18 | sh18 | sd16.5

JS10HNTV-NTPL counter stool dimensions | h39 | w18 | sh26 | sd16.5

JS10BNTV-NTPL barstool dimensions | h42 | w18 | sh29 | sd16.5

frame finish PL ● platinum powder coat | SB ● black (not available for JS10HNTV-NTPL)

wood finish NTV ● natural

materials welded steel | powder coat | ash wood veneer

seat options wood | upholstery found on pages 111 - 119 | C.O.M.

Memphis series



bench available in SB sand black only.

PRODUCT INFORMATION

JS33C+wood+frame	side chair dimensions h34.5 w17.25 sh18 sd18.5
JS33H+wood+frame	counter stool dimensions h36.25 w16.5 sh26 sd15.5
JS33B+wood+frame	barstool dimensions h40.5 w16.5 sh30.25 sd15.5
JS337ASH-SB	bench dimensions w47.25 sh18 sd14
frame finish	RU ● distressed SB ● sand black
wood finish	NT ● natural ash AA ● autumn ash GR ● gray ash
materials	welded box tube steel powder coat ash wood
seat options	wood upholstery found on pages 111 - 119 C.O.M.

Lincoln series



PRODUCT INFORMATION

JS22C+seat+back+CL	side chair dimensions h31 w16 sh18 sd13 sw15.5
JS200C+seat+CL	backless chair dimensions h18 w16 sd13 sw15.5
JS22H+seat+back+CL	counter stool dimensions h39 w18 sh26 sd13 sw15.5
JS200H+seat+CL	backless counter stool dimensions h26 w18 sd13 sw15.5
JS22B+seat+back+CL	barstool dimensions h42 w17.5 sh29 sd13 sw15.5
JS200B+seat+back+CL	backless barstool dimensions h29 w17.5 sd13 sw15.5
frame finish	CL ● clear coat
back options	AA ● autumn ash wood CL ● clear coat stamped steel
seat options	wood upholstery found on pages 111– 119 C.O.M.
materials	welded steel powder coat ash wood
feature	steel swivel glides with nylon floor protectors

Henry series



PRODUCT INFORMATION

JS88C+wood+frame side chair dimensions | h33.5 | w19 | sh17.5 | sd15.5 | sw16

JS88H+wood+frame counter stool dimensions | h38 | w19 | sh26 | sd15.5 | sw16

JS88B+wood+frame barstool dimensions | h41 | w19 | sh29 | sd15.5 | sw16

JS800H +wood+frame backless counter stool dimensions | h26 | w15.5 | sd15.5

JS800B+wood+frame backless barstool dimensions | h30.5 | w15.5

frame finish RU ● distressed | SB ● sand black

seat options wood | upholstery found on pages 111 - 119 | C.O.M.

seat wood finish NT ● natural ash | AA ● autumn ash

materials welded tubular steel | ash wood

Lima Clear Coat series



TRENT



PRODUCT INFORMATION

2160C+seat+CL side chair dimensions | h32.5 | w17.25 | sh17.5 | sd16.5

2160H+seat+CL counter stool dimensions | h39.5 | w17 | sh27 | sd16.5

2160B+seat+CL barstool dimensions | h42.5 | w17.25 | sh29 | sd16.5

2510H+seat+CL backless counter stool dimensions | h27 | w16 | sd15.75

2510B+seat+CL backless barstool dimensions | h30 | w16 | sd15.75

frame finish CL ● clear coat

standard vinyl colors BLV ● black

wood seat colors ASH ● autumn ash | NTW ● natural | CHW ● light cherry | MHW ● mahogany
WAW ● walnut | BLW ● black

relic seat colors **NC** AW ○ antique wash | CS ● chestnut | FH ● farmhouse | KP ● knotty pine |
RC ● rustic copper | VW ● vintage walnut

materials welded steel construction | powder coat

features upgraded vinyl options found on pages 111 - 119 | C.O.M.

The Screw barstool



PRODUCT INFORMATION

JS22SASH+back+frame

barstool dimensions | h40-44 | w19 | sh26-30 | sd15.75 | sw15.75

JS200SASH+frame

backless barstool dimensions | h26-30 | w19 | sh26-30 | sd15.75 | sw15.75

frame finish

CL ● clear coat | SB ● sand black

seat wood finish

AA ● autumn ash

back options

AA ● autumn ash wood | SB ● sand black | CL ● clear coat stamped steel

materials

welded tubular steel | ash wood

feature

adjustable to counter or bar height

Nash series



PRODUCT INFORMATION

JS55CASH-AA+frame	side chair dimensions h34 w22 sh18 sd16.5 sw15
JS55BASH-AA+frame	barstool dimensions h43.75 w22 sh29.5 sd16.5 sw15
frame finish	SB ● sand black RU ● distressed
wood finish	AA ● autumn ash veneer
materials	welded tubular steel veneer seat and back
feature	stackable (side chair only)



Steel seating

Lima series



PRODUCT INFORMATION

2160C+seat+SB	ladder back side chair dimensions h33 w17.25 sh17.5 sd16.5
2160B+seat+SB	ladder back barstool dimensions h43.75 w17.25 sh30.5 sd16.5
2160S+seat+SB	ladder back swivel barstool dimensions h42.5 w17.25 sh30.5 sd16.5
frame finish	sand black powder coat
standard vinyl colors	BLV ● black
wood seat colors	ASH ● autumn ash NTW ● natural CHW ● light cherry MHW ● mahogany WAW ● walnut BLW ● black
relic seat colors NC	AW ○ antique wash CS ● chestnut FH ● farmhouse KP ● knotty pine RC ● rustic copper VW ● vintage walnut
materials	welded 18 gauge steel
features	upgraded vinyl options found on pages 111 - 119 C.O.M.

Lima Silver Mist series



PRODUCT INFORMATION

2160C+seat+SM side chair dimensions | h33 | w17.25 | sh17.5 | sd16.5

2160B+seat+SM barstool dimensions | h43.75 | w17.25 | sh30.5 | sd16.5

frame finish silver mist powder coat

standard vinyl colors BLV ● black

wood seat colors ASH ● autumn ash | NTW ● natural | CHW ● light cherry | MHW ● mahogany
WAW ● walnut | BLW ● black

relic seat colors **NC** AW ○ antique wash | CS ● chestnut | FH ● farmhouse | KP ● knotty pine
RC ● rustic copper | **VW** ● vintage walnut

materials welded 18 gauge steel

features upgraded vinyl options found on pages 111 - 119 | C.O.M.

Dale series



PRODUCT INFORMATION

2150C+seat+back+SB	vener wood back side chair dimensions h33 w17.25 sh17.5 sd16.5
2150B+seat+back+SB	vener wood back barstool dimensions h43.75 w17.25 sh30.5 sd16.5
2150S+seat+back+SB	vener wood back swivel barstool dimensions h42.5 w17.25 sh30.5 sd16.5
frame finish	sand black powder coat
standard vinyl colors	BLV ● black
vener wood seat and back colors	NTW ● natural CHW ● light cherry MHW ● mahogany WAW ● walnut
materials	welded 18 gauge steel
features	upgraded vinyl options found on pages 111 - 119 C.O.M.

Espy series



PRODUCT INFORMATION

2151C+seat+back+SB	slotted veneer wood back side chair dimensions h33 w17.25 sh17.5 sd16.5
2151B+seat+back+SB	slotted veneer wood back barstool dimensions h43.75 w17.25 sh30.5 sd16.5
2151S+seat+back+SB	slotted veneer wood back swivel barstool dimensions h42.5 w17.25 sh30.5 sd16.5
frame finish	sand black powder coat
standard vinyl colors	BLV ● black
veneer wood seat and back colors	NTW ● natural CHW ● light cherry MHW ● mahogany WAW ● walnut
materials	welded 18 gauge steel
features	upgraded vinyl options found on pages 111 - 119 C.O.M.

Darby series



PRODUCT INFORMATION

2152C+seat+back+SB	circle veneer wood back side chair dimensions h33 w17.25 sh17.5 sd16.5
2152B+seat+back+SB	circle veneer wood back barstool dimensions h43.75 w17.25 sh30.5 sd16.5
2152S+seat+back+SB	circle veneer wood back swivel barstool dimensions h42.5 w17.25 sh30.5 sd16.5
frame finish	sand black powder coat
standard vinyl colors	BLV ● black
veneer wood seat and back colors	NTW ● natural CHW ● light cherry MHW ● mahogany WAW ● walnut
materials	welded 18 gauge steel
features	upgraded vinyl options found on pages 111 - 119 C.O.M.

Meghan series



NP

PRODUCT INFORMATION

JS33CM+seat+SB	side chair dimensions h34.5 w17.25 sh18 sd18.5
JS33CHM+seat+SB	counter stool dimensions h36.25 w16.5 sh26 sd15.5
JS33BM+seat+SB	barstool dimensions h40.5 w16.5 sh30.25 sd15.5
frame finish	sand black power coat
materials	welded 18 gauge steel
features	upholstery options found on pages 111 - 119 C.O.M.

Polk series



PRODUCT INFORMATION

2161C+seat+SB	perforated back side chair dimensions h33 w17.25 sh17.5 sd16.5
2161B+seat+SB	perforated back barstool dimensions h43.75 w17.25 sh30.5 sd16.5
frame finish	sand black powder coat
standard vinyl colors	BLV ● black
wood seat colors	ASH ● autumn ash NTW ● natural CHW ● light cherry MHW ● mahogany WAW ● walnut BLW ● black
relic seat colors 	AW ○ antique wash CS ● chestnut FH ● farmhouse KP ● knotty pine RC ● rustic copper VW ● vintage walnut
materials	welded 18 gauge steel
features	upholstery options found on pages 111 - 119 C.O.M.

Akryn series



PRODUCT INFORMATION

2130C+seat+SB	cross back side chair dimensions h33 w17.25 sh17.5 sd16.5
2130B+seat+SB	cross back barstool dimensions h43.75 w17.25 sh30.5 sd16.5
2130S+seat+SB	cross back swivel barstool dimensions h42.5 w17.25 sh30.5 sd16.5
frame finish	sand black powder coat
standard vinyl colors	BLV ● black
wood seat colors	ASH ● autumn ash NTW ● natural CHW ● light cherry MHW ● mahogany WAW ● walnut BLW ● black
relic seat colors 	AW ○ antique wash CS ● chestnut FH ● farmhouse KP ● knotty pine RC ● rustic copper VW ● vintage walnut
materials	welded 18 gauge steel
features	upholstery options found on pages 111 - 119 C.O.M.

Troy series



PRODUCT INFORMATION

2090C+seat+SB	slat back side chair dimensions h33 w17.25 sh17.5 sd16.5
2090B+seat+SB	slat back barstool dimensions h43.75 w17.25 sh30.5 sd16.5
frame finish	sand black powder coat
standard vinyl colors	BLV ● black
wood seat colors	ASH ● autumn ash NTW ● natural CHW ● light cherry MHW ● mahogany WAW ● walnut BLW ● black
relic seat colors 	AW ○ antique wash CS ● chestnut FH ● farmhouse KP ● knotty pine RC ● rustic copper VW ● vintage walnut
materials	welded 18 gauge steel
features	upholstery options found on pages 111 - 119 C.O.M.

Trent series



PRODUCT INFORMATION

2510B+seat+SB	metal barstool dimensions h30 w16 sd15.75
2510B+seat+CL	metal barstool dimensions h30 w16 sd15.75
2510H seat+CL	metal counter stool dimensions h27 w16 sh27 sd15.75
frame finish	CL ● clear coat SB ● sand black
standard vinyl colors	BLV ● black
wood seat colors	ASH ● autumn ash NTW ● natural CHW ● light cherry MHW ● mahogany WAW ● walnut BLW ● black
relic seat colors 	AW ○ antique wash CS ● chestnut FH ● farmhouse KP ● knotty pine RC ● rustic copper VW ● vintage walnut
materials	welded 18 gauge steel
features	upholstery options found on pages 111 - 119 C.O.M.

Bristol series



NP

PRODUCT INFORMATION

4301C+seat+SB	solid wood back side chair dimensions h33 w17.25 sh17.5 sd17
4301B+seat+SB	solid wood back barstool dimensions h43.75 w17.25 sh30.5 sd16.5
4301S+seat+SB	solid wood back swivel barstool dimensions h42.5 w17.25 sh30.5 sd16.5
frame finish	sand black powder coat
materials	welded 18 gauge steel
features	upholstery options found on pages 111 - 119 C.O.M.



Wood seating

Emma series



NP

PRODUCT INFORMATION

ZWC22+finish+seat	side chair dimensions h32.5 w17 sh17.75 sd16 sw17
ZWB22+finish+seat	barstool dimensions h42.5 w17 sh30 sd14.75 sw16
frame finish	DW ● dark walnut NT ● natural
seat options	wood graded vinyls found on pages 111 - 119 C.O.M.
custom options	wood reveal edge with upholstery on seat and back
materials	european beechwood
feature	modern mid-century design european manufactured
construction	metal hardware

Emma Cane Back series



NP

PRODUCT INFORMATION

ZWC22+finish+seat side chair dimensions | h32.5 | w17 | sh17.75 | sd16 | sw17

ZWB22+finish+seat barstool dimensions | h42.5 | w17 | sh30 | sd14.75 | sw16

frame finish NT ● natural | DW ● dark walnut

seat options wood | graded vinyls found on pages 111 - 119 | C.O.M.

custom options wood reveal edge | upholstered seat edge

materials european beechwood | synthetic cane back

feature modern mid-century design | european manufactured

construction metal hardware

Columbia series



PRODUCT INFORMATION

ZWC303+finish+seat	side chair dimensions h35.5 w18.5 sh18.5 sd16 sw18.5
ZWB303+finish+seat	barstool dimensions h43.5 w17.75 sh29.5 sd16 sw17.75
frame finish	DW ● dark walnut BL ● black stain
seat options	wood graded vinyls found on pages 111 - 119 C.O.M.
materials	european beechwood
construction	metal hardware
feature	brass footrest satin nickel finish available upon request european manufactured

Sofia series



Upcharge applies for ribbed upholstered seat.

PRODUCT INFORMATION

ZWC88+finish+seat side chair dimensions | h33.5 | w18 | sh18.75 | sd15.5 | sw15.5

ZWB88+finish+seat barstool dimensions | h42 | w18 | sh30 | sd15.5 | sw16

frame finish BW ● black walnut | CS ● vintage

seat options wood | graded vinyls found on pages 111 - 119 | C.O.M.

materials european beechwood

feature steamed bentwood | european manufactured

construction metal hardware

Giulia series



PRODUCT INFORMATION

ZWC66+finish+seat	side chair dimensions h30 w17 sh18 sd15 sw15
ZWB66+finish+seat	barstool dimensions h42.5 w17 sh30 sd14.75 sw15
frame finish	DW ● dark walnut NT ● natural BL ● black stain
seat options	wood graded vinyls found on pages 111 - 119 C.O.M.
materials	european beechwood
feature	space saving design european manufactured

Dover series



PRODUCT INFORMATION

ZWC305+finish+seat side chair dimensions | h32.5 | w18 | sh18.5 | sd17 | sw17.5

ZWB305+finish+seat barstool dimensions | h41 | w16.5 | sh30 | sd16.25 | sw16.25

frame finish DW ● dark walnut | BL ● black stain

seat options wood | graded vinyls found on pages 111 - 119 | C.O.M.

materials european beechwood

construction metal hardware

feature barstool—brass footrest | satin nickel finish available upon request | european manufactured

Aston series



PRODUCT INFORMATION

ZWC304+finish+seat	side chair dimensions h31.75 w17.25 sh18 sd16 sw17.25
ZWB304+finish+seat	barstool dimensions h43.75 w17.25 sh30.75 sd16 sw17.25
frame finish	DW ● dark walnut BL ● black stain
seat options	wood graded vinyls found on pages 111 - 119 C.O.M.
materials	european beechwood
construction	metal hardware
feature	brass footrest satin nickel finish available upon request european manufactured

Berkeley series



PRODUCT INFORMATION

	construction	metal hardware
ZWC101+finish+seat	ladder back side chair dimensions h34 w17.5 sh18.5 sd17	
ZWB101+finish+seat	ladder back barstool dimensions h44 w17.5 sh29.5 sd16	
frame finish	DM ● dark mahogany NT ● natural BL ● black stain DW ● dark walnut	
wood seat finishes	DM ● dark mahogany NT ● natural BL ● black stain DW ● dark walnut	
relic seat colors 	AW ○ antique wash CS ● chestnut FH ● farmhouse KP ● knotty pine RC ● rustic copper VW ● vintage walnut	
standard vinyl colors	BLV ● black	
seat options	wood graded vinyls found on pages 111 - 119 C.O.M.	
materials	European beechwood	
construction	metal hardware	
feature	brass footrest standard on barstool satin nickel finish available upon request European manufactured	

Stockton series



PRODUCT INFORMATION

ZWB680+finish+seat	backless barstool dimensions h30 w17.25 d15.75 sw16
frame finish	DM ● dark mahogany NT ● natural BL ● black stain DW ● dark walnut
wood seat finishes	DM ● dark mahogany NT ● natural BL ● black stain DW ● dark walnut
relic seat colors NC	AW ○ antique wash CS ● chestnut FH ● farmhouse KP ● knotty pine RC ● rustic copper VW ● vintage walnut
standard vinyl colors	BLV ● black
seat option	wood graded vinyls found on pages 111 - 119 C.O.M.
materials	european beechwood
construction	metal hardware
feature	brass footrest standard on barstool satin nickel finish available upon request european manufactured



Tables indoor

Wood Veneer table tops



VN2430 | 24 x 30

VN3030 | 30 x 30

VN3636 | 36 x 36

VN3042 | 30 x 42

VN3048 | 30 x 48

VN3060 | 30 x 60

VN3072 | 30 x 72

VN24 | 24R

VN30 | 30R

VN36 | 36R

VN48 | 48R

finish | AA ● autumn ash | NT ● natural

materials | 1¼" thick ash wood edge with ash wood veneer inlay

Midtown table tops

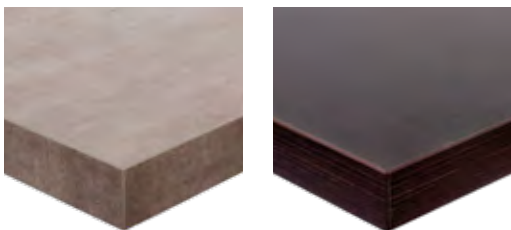

finish code+size | 24 x 24

finish code+size | 24 x 30

finish code+size | 30 x 30

finish code+size | 36 x 36

finish code+size | 30 x 42

finish code+size | 30 x 48

finish code+size | 30 x 60

finish code+size | 30 x 72

finish code+size | 24R

finish code+size | 30R

finish code+size | 36R

finish code+size | 45R

finish | CNT ● textured concrete | EST ● textured espresso
 SO ● textured sawmill oak | DW ● textured driftwood
 FF ● textured frosted slate | PP ● planked pine
 WH ○ white

materials | 1⅞" edge with honeycomb core | melamine surface with matching ABS edge

Relic table tops



- thickness+finish code+size | 24 x 30
- thickness+finish code+size | 30 x 30
- thickness+finish code+size | 36 x 36
- thickness+finish code+size | 30 x 42
- thickness+finish code+size | 30 x 48
- thickness+finish code+size | 30 x 60
- thickness+finish code+size | 30 x 72
- thickness+finish code+size | 30R
- thickness+finish code+size | 36R
- thickness+finish code+size | 48R
- thickness | 1" or 2" thick MDF core
- materials | melamine | matching PVC edge
- finish | RC ● rustic copper | FH ● farmhouse | KP ● knotty pine
 CS ● chestnut | AW ● antique wash |
 VW ● vintage walnut





Wireless table charging



np-key | magnetic key to remove batteries



np-batt | spare battery



np-charge | battery charging tray and cord *batteries not included

np-topkit-1 | single on-top starter kit (on-top coil, table dock, battery, key & charger tray with cord) *includes one battery

np-flatkit-1 | single flat mount starter kit (flat coil, table dock, battery, key & charger tray with cord) Includes installation *includes one battery

np-topkit-4 | 4 pack on-top starter kit (4 on-top coils, 4 table docks, 4 batteries, 1 key, & 1 charger tray with cord)

np-topp | wireless charger-on-top pack (on top coil, table dock & battery)

np-flatp | wireless charger, flat pack (flat coil, table dock, battery & installation) see tops with flat chargers

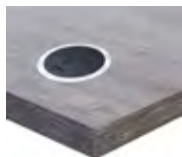

Indoor bases



Jaxon

- BXS-2020 | 20" cross base | dining height
- BXS-2020T | 20" cross base | bar height
- BXS-2424 | 24" cross base | dining height
- BXS-2424T | 24" cross base | bar height
- top plate | 1 1/4" bolt on plate
- finish | sand black
- materials | stamped steel
- column | 3" square
- feature | unique vertical design



Jaxon

- BXS-0024 | 24" end base | dining height
2-pc set
- BXS-0024T | 24" end base | bar height
2-pc set
- top plate | 1 1/4" bolt on plates
- finish | sand black
- materials | stamped steel
- column | 3" square
- feature | unique vertical design



Uptown

- LP-18R | 18" round base | dining height
- LP-18RT | 18" round base | bar height
- LP-20R | 20" round base | dining height
- LP-20RT | 20" round base | bar height
- LP-24R | 24" round base | dining height
- LP-24RT | 24" round base | bar height
- top plate | 1 1/4" bolt on plate
- finish | sand black | white
- materials | stamped steel
- column | 3" round
- features | thin profile design



Uptown

- LP-18SQ | 18" square base | dining height
- LP-18SQT | 18" square base | bar height
- LP-20SQ | 20" square base | dining height
- LP-20SQT | 20" square base | bar height
- LP-24SQ | 24" square base | dining height
- LP-24SQT | 24" square base | bar height
- top plate | 1 1/4" bolt on plate
- finish | sand black | white
- materials | stamped steel
- column | 3" square
- features | thin profile design

Indoor bases



Uptown

- LP-0024SQ | 24" end base | dining height | 2-pc set
- LP-0024SQ | 24" end base | bar height | 2-pc set
- top plate | 11 3/4" bolt on plate
- finish | sand black | white
- materials | stamped steel
- column | 3" square
- feature | thin profile design

Indoor



- STB+size+height | round base
- base diameter | 18 | 22 | 30
- finish | sand black
- materials | stamped steel
- top plate | welded | BP bolt on plate
- dining | C counter | T bar height
- 3" or 4" diameter columns (3" column welded plate 7.8 x 7.8" | 3" or 4" column bolt-on plate 11.8 x 11.8")

Indoor foot ring



- STB+base size+TFR | base with foot ring
- available in all cross and round sizes
- finish | sand black
- materials | stamped steel
- top plate | welded
- feature | 3" or 4" diameter columns (3" column welded plate 7.8 x 7.8")

Niles



- PHTB500 | round base | dining height
- PHTB500T | round base | bar height
- base diameter | 20
- finish | sand black
- materials | cast iron
- feature | ornate base plate

Indoor



- ST+size+height | cross base
- base spread | 22 x 22 | 24 x 30 | 30 x 30
36 x 36
- finish | sand black
- materials | stamped steel
- top plate | welded | BP bolt on plate
- dining | C counter | T bar height
- 3" or 4" diameter columns (3" column welded plate 7.8 x 7.8" | 3" or 4" column bolt-on plate 11.8 x 11.8")

Indoor



- STB-0022 | dining height (sold separately)
- STB-0022CBP | counter height (sold separately)
- STB-0022T | bar height (sold separately)
- base spread | 5 x 22 | 2 required per top
- finish | sand black
- materials | stamped steel
- top plate | welded | BP bolt on plate
- feature | ADA capabilities
- (3" column welded plate 7.8 x 7.8" | 3" column bolt-on plate 11.8 x 11.8")

Indoor / Outdoor bases



Alpha indoor | outdoor

- PHTBBD+finish | bolt-down base
- PHTBBDT+finish | bolt-down base
- finish | SS stainless | BL black | SV silver
- materials | 304 stainless steel
- dining or bar height
- feature | ADA capabilities | bolt down



Elite indoor | outdoor

- PHTB+size+SQSS | square | dining height
- PHTB+size+SQSST | square | bar height
- base spread | 18 x 18 | 24 x 24
- top plate | 11.8" x 11.8"
- materials | 304 brushed stainless steel
- dining or bar height



Elite indoor | outdoor

- PHTB+size+RSS | round | dining height
- PHTB+size+RSST | round base bar height
- base diameter | 18 | 24
- top plate | 11.8" x 11.8"
- materials | 304 brushed stainless steel
- dining or bar height



Elite indoor | outdoor

- PHTB0024SS | dining height (sold as pair)
- PHTB0024SST | bar height (sold as pair)
- base spread | 4 x 24
- top plate | 11.8" x 11.8"
- materials | 304 brushed stainless steel
- feature | ADA capabilities



Elite double column indoor | outdoor

- PHTB1630SS | dining height
- PHTB1630SST | bar height
- base spread | 16 x 30
- top plate | 11.8" x 11.8"
- materials | 304 brushed stainless steel

Indoor bases



Corner Post leg

TB-SQ2 | 2" square post | dining height
(sold as set of 4)

TB-SQ3 | 3" square post | dining height
(sold as set of 4)

finish | sand black

materials | steel and powder coat

feature | ADA capabilities



NV corner leg

NV4L-SB | dining height
(sold as set of 4)

NV4L-SBC | counter height
(sold as set of 4)

NV4L-SBT | bar height
(sold as set of 4)

finish | black

materials | solid rod steel

feature | matches NV chair series
ADA capabilities



Cantilever

TB-C22 | bracket 22" long

TB-C33 | bracket 33" long

TB-P125 | pin leg 1.25

finish | glossy black powder coat
black wrinkle (pin leg)

materials | welded steel

feature | wall mounting



Bolt-down base

TB-BD | base | dining height

TB-BDT | base | bar height

TB-BDC | base | counter height

finish | black wrinkle

materials | welded steel

feature | cover plate



I-beam

JSTB3636+height | 36 x 36

JSTB3048+height | 30 x 48

JSTB3648+height | 36 x 48

JSTB3060+height | 30 x 60

JSTB3660+height | 36 x 60

JSTB3072+height | 30 x 72

JSTB3672+height | 36 x 72

finish | black powder coat

materials | steel

features | electric outlet capability | frame manufactured
to conceal hardwiring
(Outlets & wiring not included. Cover plates included for unused outlet cutouts.)

dining height BL or bar height BLT

Power up option / USB charging

Trash receptacles



TE4622CS | trash receptacle

finish | CS ● chestnut

material | melamine | MDF

feature | holds standard 35 gallon plastic container, size 19" w x 19" D x 27" H

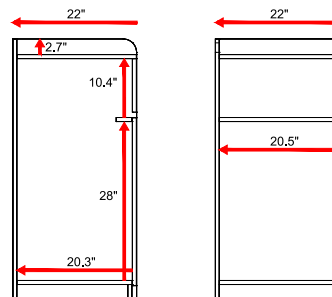

NC

TE4622VW | trash receptacle

finish | VW ● vintage walnut

material | melamine | MDF

feature | holds standard 35 gallon plastic container, size 19" w x 19" D x 27" H



TE4622KP | trash receptacle

finish | KP ● knotty pine

material | melamine | MDF

feature | holds standard 35 gallon plastic container, size 19" w x 19" D x 27" H

Trash receptacles



TE4622RC | trash receptacle

finish | RC ● rustic copper

material | melamine | MDF

feature | holds standard 35 gallon plastic container, size 19"w x 19"D x 27"H



TE4622AW | trash receptacle

finish | AW ● antique wash

material | melamine | MDF

feature | holds standard 35 gallon plastic container, size 19"w x 19"D x 27"H



TE4622FH | trash receptacle

finish | FH ● farmhouse

material | melamine | MDF

feature | holds standard 35 gallon plastic container, size 19"w x 19"D x 27"H

Server stations – single door



WS4024CS | server station

finish | CS ● chestnut

material | melamine | MDF

feature | drawer and inside shelf

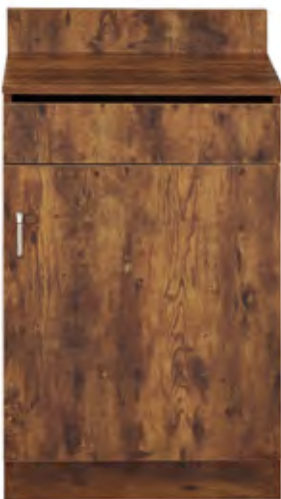
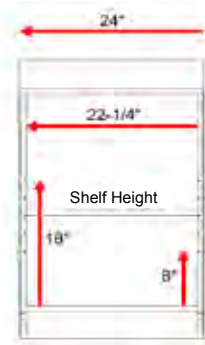
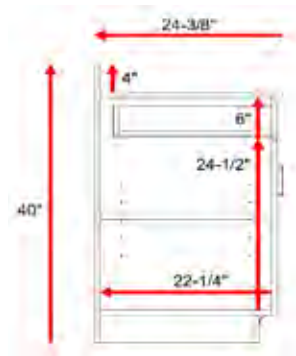

NC

WS4024VW | server station

finish | VW ● vintage walnut

material | melamine | MDF

feature | drawer and inside shelf



WS4024KP | server station

finish | KP ● knotty pine

material | melamine | MDF

feature | drawer and inside shelf

Server stations – single door



WS4024RC | server station

finish | RC ● rustic copper

material | melamine | MDF

feature | drawer and inside shelf

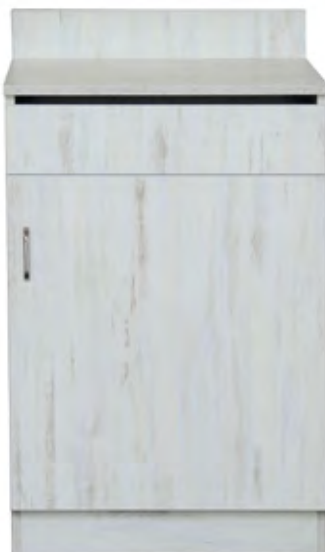

WS4024AW | server station

finish | AW ● antique wash

material | melamine | MDF

feature | drawer and inside shelf



WS4024FH | server station

finish | FH ● farmhouse

material | melamine | MDF

feature | drawer and inside shelf

Server stations – double door



WS4047CS | server station

finish | CS ● chestnut

material | melamine | MDF

feature | 2 drawers and 2 inside shelves

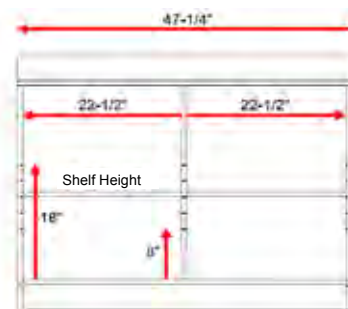

NC

WS4047VW | server station

finish | VW ● vintage walnut

material | melamine | MDF

feature | 2 drawers and 2 inside shelves



WS4047KP | server station

finish | KP ● knotty pine

material | melamine | MDF

feature | 2 drawers and 2 inside shelves

Server stations – double door



WS4047RC | server station

finish | RC ● rustic copper

material | melamine | MDF

feature | 2 drawers and 2 inside shelves



WS4047AW | server station

finish | AW ● antique wash

material | melamine | MDF

feature | 2 drawers and 2 inside shelves



WS4047FH | server station

finish | FH ● farmhouse

material | melamine | MDF

feature | 2 drawers and 2 inside shelves

Quick Ship Vinyl



Black

For products on pages 64, 71, 75-79, 81-84, 94 & 95.

Steel seating wood seat options



Natural



Light Cherry



Autumn Ash



Mahogany



Walnut



Black

For products on pages 71, 75-79, (76 only Autumn Ash), (77-79 no Black and no Autumn Ash), 81-84.

Relic seat options

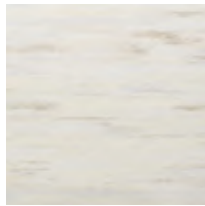

Antique Wash



Chestnut



Farmhouse



Knotty Pine



Rustic Copper



Vintage Walnut

NC

Grade 2 Vinyl



American Beauty
VNS-001



Aqua Green
VNS-002



Avocado
VNS-003



Black Walnut
VNS-004



Blue Ridge
VNS-005



Bright Yellow
VNS-006



Burgundy
VNS-007



Chocolate Chip
VNS-008



Claret
VNS-009



Concord
VNS-010



Ebony
VNS-013



Forest
VNS-016



Georgia Clay
VNS-017



Graphite
VNS-018



Indigo
VNS-020

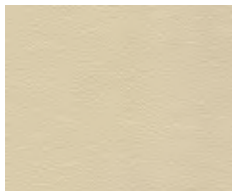

Ivory
VNS-021



Kelly Green
VNS-023

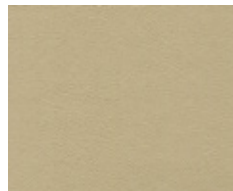

Mushroom
VNS-025

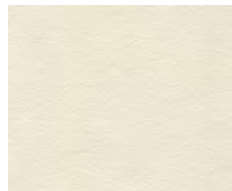

Pearl
VNS-027



Royal Blue
VNS-029

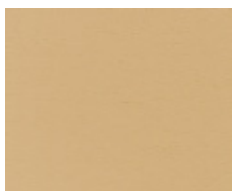

Sand
VNS-030

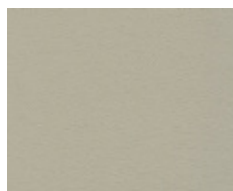

Silver Grey
VNS-031

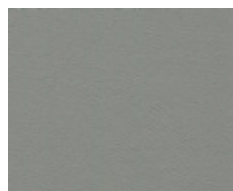

Silver Surf
VNS-032



Sky Blue
VNS-033

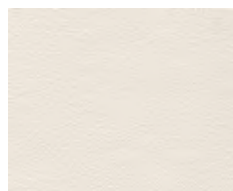

Super White
VNS-034



Tan
VNS-035

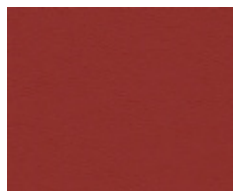

Tea Rose
VNS-037



Tiger Lily
VNS-038



Yellow Gold
VNS-040

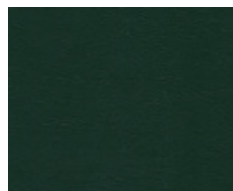

Yew Green
VNS-041

Grade 3 Vinyl



MOD-2001
FARRO



MOD-2002
BLUEBIRD



Grade 4 Vinyl



Gauze STT-007



Cotton STT-005



Sheer STT-019



Parchment STT-015



Burlap STT-002



Hemp STT-009



Spindel STT-020



Tobacco STT-022



Linen STT-013



Oxford STT-014

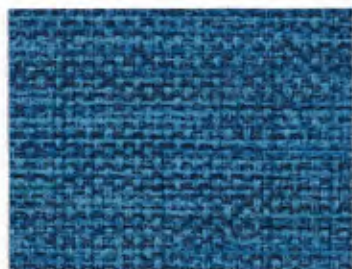

Chambray STT-004



Rafia STT-016



Grasscloth STT-008

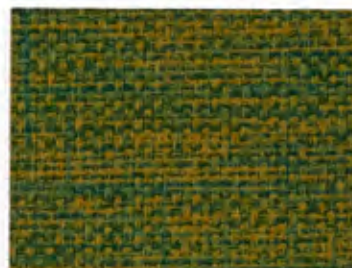

Bamboo STT-001

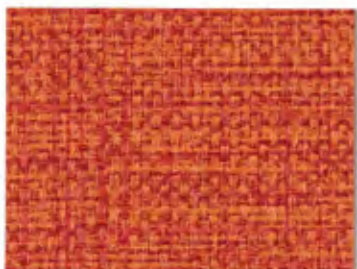

Sari STT-017



Henna STT-010



Cadmium STT-003

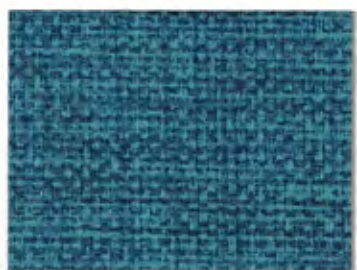

Scuba STT-018



Indigo STT-011



Tapestry STT-021

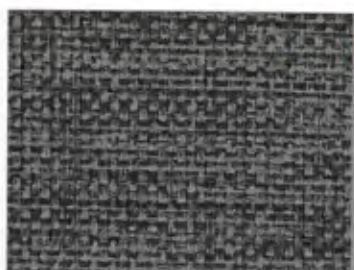

Worsted STT-023



Flannel STT-006



Kona STT-012

Grade 4 Vinyl - Whisper

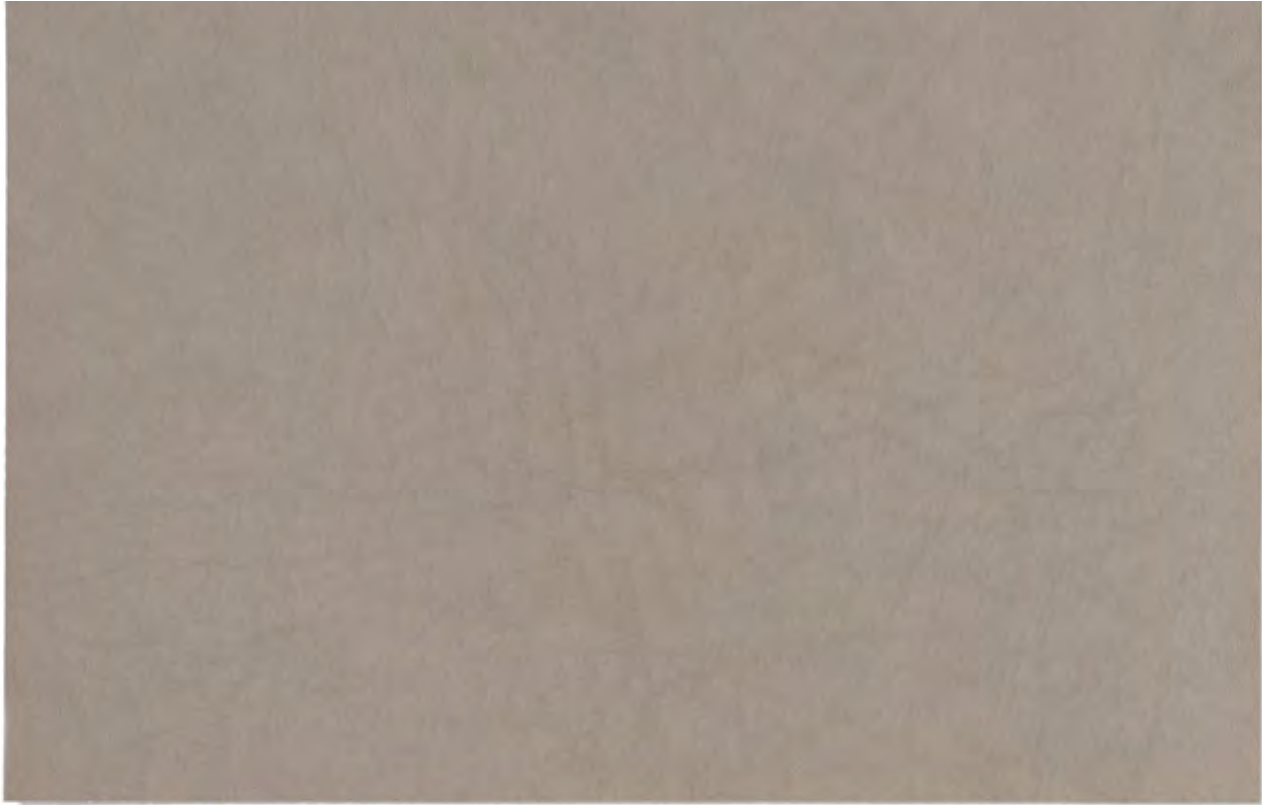

WHI-2174
PAVESTONE

NEW



WHI-2170
POWDER

NEW



WHI-2171
PEARL

NEW



WHI-2117
BONE



WHI-2172
SAND

NEW



WHI-2173
FARRO

NEW



WHI-2118
CAMEL



WHI-2141
CASHEW



WHI-2150
FAWN



WHI-2120
ANTELOPE



WHI-2121
CAPPUCCINO



WHI-2142
COGNAC



WHI-2123
LUGGAGE



WHI-2183
SADDLE

NEW



WHI-2125
CINNAMON



WHI-2182
AUBURN

NEW



WHI-2181
COASTAL **NEW**



WHI-2136
CERULEAN



WHI-2137
NAVY



WHI-2175
TERRACOTTA **NEW**



WHI-2126
BORDEAUX



WHI-2184
SLATE **NEW**



WHI-2161
MALLARD



WHI-2163
INDIGO



WHI-2124
SALSA



WHI-2165
MOLTEN



WHI-2138
ELEPHANT



WHI-2180
EMERALD **NEW**



WHI-2177
ISLET **NEW**



WHI-2176
BREEZE **NEW**



WHI-2162
PARADISE



WHI-2155
STORM



WHI-2179
HERBAL **NEW**



WHI-2178
SILVER LEAF **NEW**



WHI-2134
PATINA



WHI-2160
SASSAFRAS



WHI-2152
MAHOGANY



WHI-2157
FOG



WHI-2186
WOLF GREY **NEW**



WHI-2154
PEWTER



WHI-2185
FOSSIL **NEW**



WHI-2153
TRUFFLE



WHI-2143
ESPRESSO



WHI-2139
CHARCOAL



WHI-2140
BLACK

Grade 4 Vinyl

 Adobe White US 394	 Ivory US 500	 Coral Sand US 502	 Froth US 501	 Surf US 513	 Fjord Blue US 517	 Bristol Blue US 515	 Pink US 503	
 Alabaster US 396	 Parchment US 385	 Shell US 402	 Sand US 384	 Dusty Jade US 417	 Turquoise US 419	 Dutch Blue US 518	 Mauve US 415	
 Taupe US 410	 Bone US 404	 Peach US 406	 Vicuna US 401	 Northwoods US 528	 Grotto US 426	 Wedgewood US 414	 Tea Rose US 416	
 Putty US 403	 Bisque US 409	 Rose US 412	 Doe US 519	 Lilac US 508	 Sage US 526	 Space Blue US 353	 Rouge Red US 505	
 Gray Moss US 525	 Dewberry US 424	 Sunset US 521	 Camel US 387	 Crocus US 433	 Artichoke US 527	 Royal US 354	 Raspberry US 362	
 Dove US 413	 Woodrose US 423	 Paprika US 370	 Oak US 421	 Deep Violet US 511	 Olive Green US 529	 Regimental Blue US 345	 Dark Cherry US 507	
 Greystone US 425	 Chestnut US 375	 British Tan US 365	 Terra Cotta US 376	 Grape US 509	 Alpine US 530	 Imperial Blue US 432	 American Beauty US 360	
 Gunmetal US 392	 Bronze US 523	 Gingersnap US 369	 Cinnamon US 377	 Sangria US 506	 Forest US 344	 Sky Blue US 516	 Tomato US 358	
 Blue Ridge US 427	 Mocha US 381	 Cinnabar US 520	 Goldenrod US 324	 Plum US 361	 Yew Green US 350	 Capri Blue US 514	 Rosalee US 504	
 Graphite US 429	 Rustic Brown US 522	 Claret US 357	 Golden Corn US 524	 Dark Purple US 512	 Emerald US 343	 China Green US 434	 Mandarin Orange US 372	
 Black US 393	 Espresso US 383	 Burgundy US 364	 Sun Yellow US 322	 Concord US 510				

Grade 4 Tailor Made Textile Upholstery

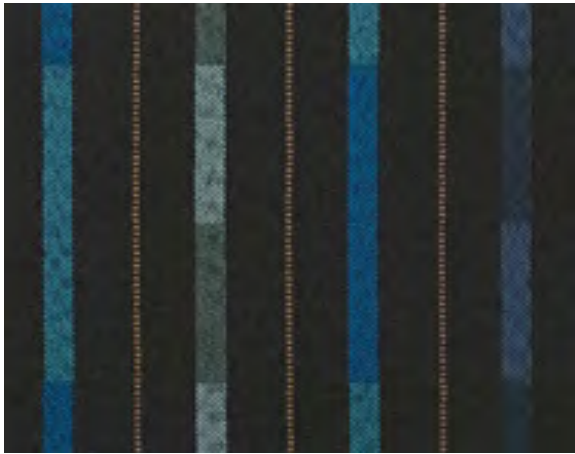

Cabana 2358-412

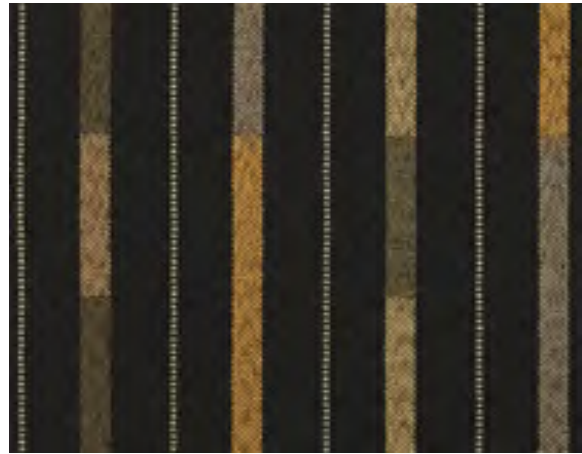

City Lights 2358-200

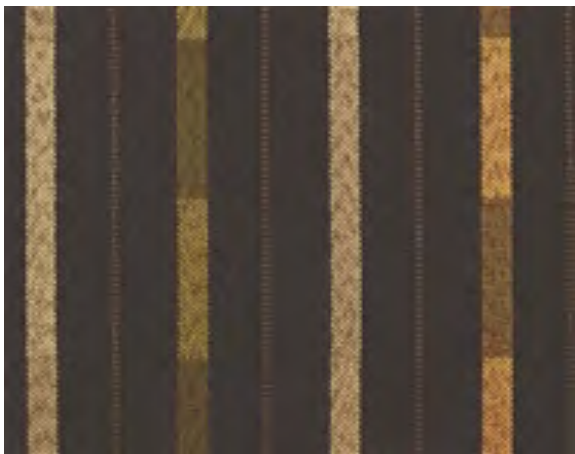

Marshland 2358-414



Nightshade 2358-134



Horizon 2358-410

Sunbrella® Sofa Cushion Canvas

Aruba & Belmar series



Twilight
14089-0000



Glacier
5428-0000



Mineral Blue
5420-0000



Sky Blue
5424-0000



Cyan
56105-0000



Sapphire Blue
5452-0000



Air Blue
5410-0000



Regatta
5493-0000



Pacific Blue
5401-0000



Capri
5426-0000



Haze
14059-0054



Abyss
14066-0000



Aruba
5416-0000



True Blue
5499-0000



Navy
5439-0000



Ginkgo
54011-0000



Teal
5456-0000

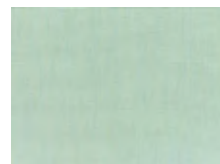

Spa
5413-0000



Forest Green
5446-0000

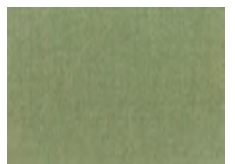

Fern
5487-0000



Macaw
5429-0000



Seasalt
14106-0000



Buttercup
5438-0000



Sunflower
5457-0000

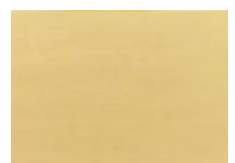

Wheat
5414-0000

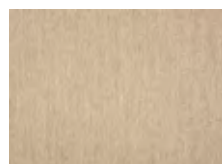

Fawn
57015-0000



Mushroom
14067-0000

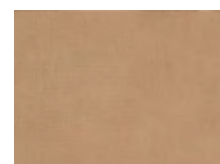

Raffia
14107-0000

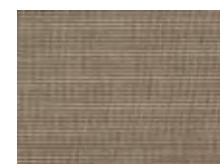

Flint
14090-0000

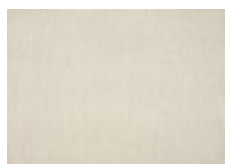

Cloud
57012-0000

Sunbrella® Sofa Cushion Canvas

Aruba & Belmar series



Tangerine
5406-0000



Tuscan
5417-0000



Rust
54010-0000



Melon
5415-0000



Tamale
14086-0000



Persimmon
57013-0000



Logo Red
5477-0000



Jockey Red
5403-0000

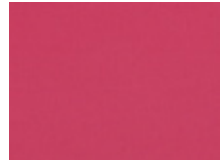

Hot Pink
5462-0000



Terracotta
5440-0000



Brick
5409-0000

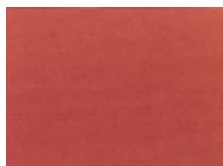

Henna
5407-0000



Burgundy
5436-0000



Heather Beige
5476-0000



Camel
5468-0000



Cocoa
5425-0000

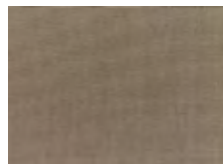

Taupe
5461-0000



Teak
5488-0000



Bay Brown
5432-0000



Java
57014-0000



Raven Black
5471-0000

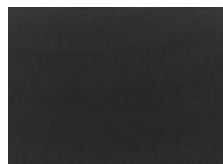

Black
5408-0000



Coal
5489-0000



Charcoal
54048-0000

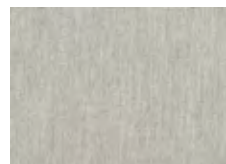

Granite
5402-0000

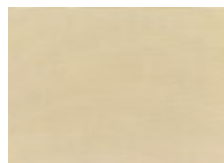

Antique Beige
5422-0000

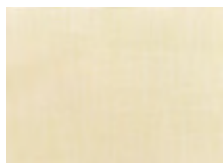

Vellum
5498-0000

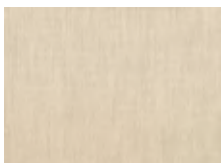

Flax
5492-0000

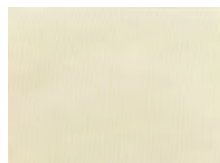

Birds Eye
5472-0000

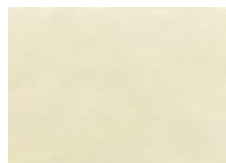

Canvas
5453-0000



Skyline
14091-0000

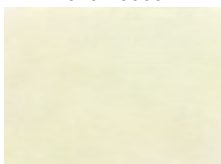

Natural
5404-0000

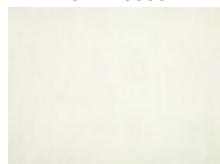

White
57003-0000



Please contact us about our custom cushion capabilities.

Sunbrella® Sofa Cushion Fabric Patterns

Aruba & Belmar series



Palma 68 Renew



Palma 09 Bahama



Palma 20 Canopy



Nema 62 Pampas



Nema 41 Lazuli



Nema 55 Newsprint



Nema 49 Moonlight



Nema 83 Teak

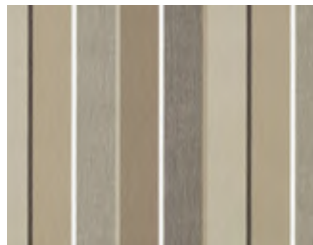

Milano Char 56079-0000



Milano Cobalt 56080-0000



Please contact us about our custom cushion capabilities.



9 oz Umbrella Canvas

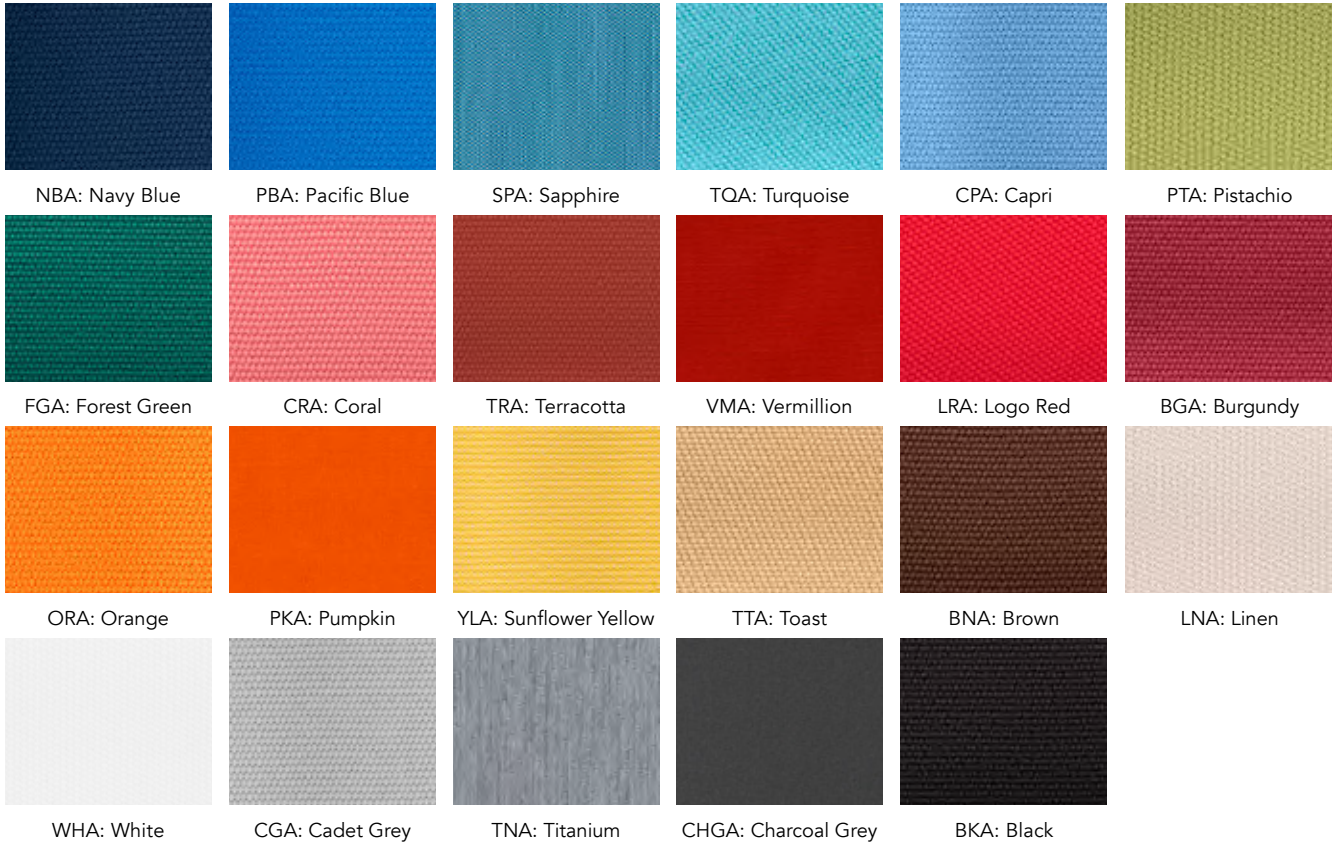

STRIPES REPEATING PATTERN: 6.4"



Umbrella base guide by application

Umbrella Bases	Umbrella sizes											
	Market umbrellas - 1 1/2" Pole					G-series - 2" pole			Cantilever		Bolt-down	
	6.5'	7.5SQ'	7.5'	9'	11'	13'	10'	8.5x11'	10SQ'	13R'	13SQ'	16R'
UB50RD	T	T	T	T	T							
UB70RD	T	T	T	T	T							
UB75SQ	S		S	S								
UB100RSM	TS	T	TS	TS	T							
UB150RSM	S	S	S	S	S	S	S	S				
UBG24RSM	T	T	T	T	T							
UBG30RSM	S	S	S	S	S							
UBG36RSM	S	S	S	S	S	S	S	S				
UBG40RSM	S	S	S	S	S	S	S	S				
UBG40R555									S	S		
UB480						S	S	S				
UB550									S	S	S	S
UB12DP									S	S		
UB20DP											S	S
UBBD	S	S	S	S	S							
UBINGF									S	S	S	S

T = Table use S = Stand-alone TS = Table use or Stand-alone

T Table use: Indicates the base is suitable for use beneath a table. It is not recommended as a stand-alone base option.

S Stand-alone: Indicates the base is recommended as a stand-alone base option. It is not recommended as a table use base option.

TS Table use or Stand-alone: Indicates the base is suitable for use beneath a table or as a stand-alone base option.

Table use bases require an 8" stem option and stand-alone bases require an 18" stem option.

Indoor base sizing guide

Table Base	Table Size										
	24"/30" Round	36" Round	45"/48" Round	24" Square	30" Square	36" Square	24x30"	30x42"	30x48"	30x60"	30x72"
See outdoor table base guide for more base options											
Jaxon End base set								•	•	•	•
Jaxon 20x20 Cross bases	•			•	•		•				
Jaxon 24x24 Cross bases		•				•					
Atlas 30x48 A-Frame									•		
Atlas 30x60 A-Frame										•	
Atlas 30x72 A-Frame											•
Urban 30x48 Loop Frame									•		
Urban 30x60 Loop Frame										•	
Urban 30x72 Loop Frame											•
Niles 20" Round Bases	•	•		•	•		•		2	2	2
Stamped Steel End bases								2	2	2BP	2BP
Stamped Steel 22x22 Cross bases	•			•	•		•				
Stamped Steel 24x30 Cross bases								•			
Stamped Steel 30x30 Cross bases		•				•					
Stamped Steel 36x36 Cross bases			•								
Stamped Steel 18" Round bases	•			•	•		•		2	2BP	2BP
Stamped Steel 22" Round bases		•			•	•				2BP	2BP
Stamped Steel 30" Round bases			•								
TB-BD Bolt-Down bases	•	•		•	•		•	2	2		
TB-C22 22" Cantilever Bracket				•	•		•				
TB-C33 33" Cantilever Bracket Also requires TB-P125 if marked PL (Pin Leg)						•		•	PL	PL	PL
NV corner leg sets NV4L				•	•	•	•	•	•	•	•
TB-SQ corner leg sets 2" or 3"				•	•	•	•	•	•	•	•
Uptown End base set								•	•	•	•
Uptown 18" Round or Square bases	•			•	•		•		2	2	2
Uptown 20" Round or Square bases		•			•						
Uptown 24" Round or Square bases		•	•			•					

2 = two bases required per top / 2BP = two Bolt-On plate bases required per top
 PL = TB-C33 & TB-P125 are both required.

I-BEAM Bases	36" Square	30x48"	30x60"	30x72"	36x48"	36x60"	36x72"
JSTB3636BL & JSTB3636BLT	•						
JSTB3048BL & JSTB3048BLT		•					
JSTB3060BL & JSTB3060BLT			•				
JSTB3072BL & JSTB3072BLT				•			
JSTB3648BL & JSTB3648BLT					•		
JSTB3660BL & JSTB3660BLT						•	
JSTB3672BL & JSTB3672BLT							•

Outdoor base sizing guide

Table base & top name	Table top size											
	24" Round	30 & 32" Round	36" Round	42" Round	48" Round	24" Square	30 & 32" Square	34 & 36" Square	24x30" 24x32"	30x51" 32x48"	30x60" 30x72"	Umbrella Compatible
Outdoor bases can also be used with indoor tops												
Alpha Bolt-Down Longport, Seaside, Tribeca	•	•	•			•	•		•	2		
Bali Longport, Seaside, Tribeca	•	•	•			•	•	•	•			
Bali End Base Set Longport, Seaside, Tribeca										•	•	UB
Boca 24" Spread Tribeca*	•	•				•	•		•			
Boca 33" Spread Tribeca*		•	•	•	•		•	•				UB
Boca Trestle Tribeca*										•		
Elite 18" Round Longport, Seaside, Tribeca	•	•				•	•		•	2	2	
Elite 18" Square Longport, Seaside, Tribeca	•	•	•			•	•		•	2	2	
Elite 24" Round Longport, Seaside, Tribeca			•	•	•			•				
Elite 24" Square Longport, Seaside, Tribeca				•	•			•				
Elite End Base Set Longport, Seaside, Tribeca										•	•	UB
Elite Double Column 16x30"										•		
Margate 16" Round Longport, Seaside, Tribeca	•					•						
Margate 16" Square Longport, Seaside, Tribeca	•					•			•			
Margate 18" Round or Square Longport, Seaside, Tribeca	•	•				•	•		•			UC
Margate 20" Round Longport, Seaside, Tribeca			•									UC
Margate 20" Square Longport, Seaside, Tribeca			•					•				UC
Margate 24" Round or Square Longport, Seaside, Tribeca				•	•			•				UC

*Tribeca tops on Boca bases require special drilling

UB = Umbrella Base required / UC = Column holds umbrella / 2 = two bases required per top

Terms & Conditions

Orders & Cancellations

All orders, order changes or cancellations must be placed in writing by fax or e-mailed to orders@bfm1.com. Special orders require a 50% deposit. Canceled orders that have been assembled are subject to a minimum 25% restocking charge plus any material and labor charges not covered by the minimum restock charge.

Customers are responsible for any and all costs expended by BFM for changes or cancellations including but not limited to special upholstery, production and labor costs. Custom upholstered/manufactured items such as but not limited to umbrellas, sofa cushions/pillows & seats cannot be canceled once production has started.

Terms and Conditions

Credit terms are established on an individual basis. Special orders require a 50% deposit. Product not picked up or shipped within 30 days needs to be paid for in full to continue to be held for an additional 30 days. Product held beyond 60 days will incur a 1.5% storage charge per month beginning on the 61st day.

Returns

Merchandise cannot be returned without a written return authorization. Approved returns are subject to a minimum 25% restocking charge. Freight out and return freight will be the customer's responsibility. Return will be approved upon inspection. If you wish to return your product, simply call 215-289-5411 or email us at

returns@bfm1.com for a return authorization number (RA). All returns must be in the original condition and packaging. All returns will be subject to a 25% restocking fee.

Please Note: Any product ordered that has been custom built or manufactured includes but is not limited to; umbrellas, sofa cushions/pillows, custom upholstered seats are not returnable.

Freight & Freight Claims

BFM will ship by our carrier unless instructed otherwise on purchase order. All shipments are FOB our Philadelphia warehouse. PO must specify Prepaid & Add, Third Party or Freight Collect. BFM reserves the right to ship items FOB factory as circumstances may dictate. When the freight leaves our facility it is signed for in good order by the freight carrier. At this point the freight is no longer ours. It is the responsibility of the consignee to inspect the goods upon arrival. In the event there is not time to open cartons and inspect all items, the bill of lading should be signed subject to inspection. If any damage is found, it is the responsibility of the consignee to report the damage to the freight carrier and BFM Seating within 24 hours of receiving shipment. BFM will not be held responsible for carrier delays in delivery or any other circumstances beyond BFM's control.

Product Care

Product should be inspected on a regular basis for loose screws, glides, cracked or broken welds, cracked laminate, or any other irregularities.

Synthetic Teak: Wash with mild soap and warm water. Metal: Use a damp cloth. For grease and other stains use a combination of mild soap and water and wash thoroughly.

Wood: Coat with hard paste wax every few months for the first year and then as needed thereafter. Liquid spills should

be cleaned up immediately. A liquid wood cleaner/wax product should be used for general cleaning. Do not use any solvents, abrasive or other harsh cleaners.

Upholstery: Vinyls may be cleaned with mild soap and water or vinyl cleaner (do not use any ammonia or chlorine products).

For fabric upholstery verify cleaning procedure with manufacturer of the fabric or check with us.

Laminated Table Tops: Use mild soap and water (do not use any ammonia or chlorine products).

Warranty

The furniture in this catalog carries the following 1 year limited warranty against defects in construction to the original end user purchaser. Warranty is void if product is not maintained, altered in any fashion, mistreated or misused.

Extent of warranty is to cover workmanship and material of frames and does not cover upholstery, umbrellas or other materials. Other materials are governed by manufacturer's warranty. Warranty does not cover normal wear & tear.

This limited warranty is in lieu of all other warranties express or implied and BFM Seating expressly disclaims any implied warranties of merchantability or fitness for particular purpose. In no instance shall BFM Seating's liability under warranty exceed the value of the warranted item or items. Warranty as expressed does not include replacement freights or installation/removal. All warranty claims are subject to the following:

- Synthetic Teak: Excessive heat from the following sources voids warranty, prism affect of sun on footed glassware, metal objects such as condiment stands and any other object that creates excessive heat.
- Consumer properly assembling KD items
- Product is subject to normal use. Indoor furniture may not be subject to outdoor use or extremes in temperature & humidity. Outdoor furniture may not be subject to winter weather elements or excessive weather elements of any type.
- Umbrellas should not be subject to excessive wind or used in unsafe conditions in open or closed position.
- Warranty Claims must include pictures of subject product & may also require return for inspection. If returned product is deemed as abused return freight will be the responsibility of returning party.
- BFM reserves the right to determine under warranty to replace applicable part(s) or complete item.
- For any reason if any product is to be returned, a return authorization must be obtained before returning. Any product returned without a return authorization will be refused and all shipping costs will be the responsibility of the shipping party.

We reserve the right to update or discontinue products without notice.

If the buyer is concerned about exact color, texture, or stain, we strongly encourage you to request a sample swatch by contacting us. Colors may vary from catalog or website images. We are not responsible for discrepancies in color, texture, or stain if a sample swatch is not requested.

If you are an authorized dealer/vendor of BFM, BFM will add you as an additional insured under BFM's liability insurance upon request.



2080 Wheatsheaf Lane
Philadelphia, PA 19124
215.289.5411 **P**
215.289.5420 **F**
bfmseating.com